

# Solis



**Solis 20**

**OPERATOR MANUAL**

A Product of  
  
**SONALIKA**  
**INTERNATIONAL**



# Solis

## Solis 20

### OPERATOR MANUAL



**INTERNATIONAL TRACTORS LIMITED**  
**HOSHIARPUR**



## EIGENAAR EN TRACTOR DETAILS

<b>EIGENAARS NAAM &amp; ADRESS</b>	_____ _____ TEL.NO. _____
--	------------------------------

Model :	Afleverdatum :
Chassis No. :	Factuur No. / Datum :
Motor No. :	Dynamo Gemaakt / Sr. No. :
Batterij Gemaakt / Sr. No. :	Start motor Gemaakt / Sr. No. :
FIP Sr. No. :	Hydraulische Pomp Gemaakt / Sr. No. :

Banden	Gemaakt	Maat	Sr. No.
Voor (Links)			
Voor (Rechts)			
Achter (Links)			
Achter (Rechts)			

Ik ga akkoord met alle voorwaarden ten behoeven van het onderhoud van de trekker, de garantievoorzaken, de systemen, de geregelde diensten & ik begrijp de werking van de trekker in het veld en met het gebruik tijdens andere verrichtingen.

Ontving een nieuwe defectvrije tractor Chassis No. ....

Motor No. .... & ben volkomen tevreden met de transactie.

<b>HANDTEKENING EIGENAAR</b>	<b>HANDTEKENING DEALER</b>
	TEL. NO. .... DATUM: .....

\* **BELANGRIJKE INFORMATIE VOOR DE AFNEMER:** Voor hulp met betrekking tot ons product, neem dan contact op met onze geautoriseerde dealer of erkend servicecentrum.

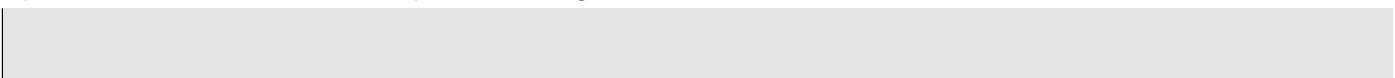



## EIGENAAR EN TRACTOR DETAILS

<b>EIGENAARS NAAM &amp; ADRESS</b>	_____  _____TEL.NO. _____
--	---------------------------------

Model :	Afleverdatum :
Chassis No. :	Factuur No. / Datum :
Motor No. :	Dynamo Gemaakt / Sr. No. :
Batterij Gemaakt / Sr. No. :	Start motor Gemaakt / Sr. No. :
FIP Sr. No. :	Hydraulische Pomp Gemaakt / Sr. No. :

Banden	Gemaakt	Maat	Sr. No.
Voor (Links)			
Voor (Rechts)			
Achter (Links)			
Achter (Rechts)			

Ik ga akkoord met alle voorwaarden ten behoeven van het onderhoud van de trekker, de garantievoorzwaarden, de systemen, de geregelde diensten & ik begrijp de werking van de trekker in het veld en met het gebruik tijdens andere verrichtingen.

Ontving een nieuwe defectvrije tractor Chassis No. ....

Motor No. .... & ben volkomen tevreden met de transactie.

<b>HANDTEKENING EIGENAAR</b>	<b>HANDTEKENING DEALER</b>
	TEL. NO. .... DATUM: .....

\* **BELANGRIJKE INFORMATIE VOOR DE AFNEMER:** Voor hulp met betrekking tot ons product, neem dan contact op met onze geautoriseerde dealer of erkend servicecentrum.







## INLEIDING

Geachte Afnemer, wij verwelkomen u met veel plezier in uw toetreding tot de ITL familie en bedanken u voor het vertrouwen dat in ons heeft door uw zorgvuldige keuze te laten vallen op een van onze tractoren. Voor het gebruik van deze tractor wordt u sterk aanbevolen om deze handleiding zorgvuldig door te lezen. Elke persoon die regelmatig of incidenteel uw tractor gebruikt wordt geacht deze instructies door te lezen.

Werkzaamheden als dagelijks en routineonderhoud, kunnen eenvoudig worden uitgevoerd met behulp van deze handleiding. Onze dealers staan altijd klaar om u te assisteren met het onderhoud van uw tractor en de zuinige afstelling ervan.

Gebruik alleen originele Sonalika onderdelen van erkende dealers en leveranciers. Zo bent u verzekert van een betrouwbare en optimaal presterende tractor.

De informatie verstrekt in deze handleiding is correct op het moment van drukken.

Verbetering en aanpassingen zijn een continue proces bij International Tractor Limited (ITL), en zijn voorbehouden wijzigingen door te voeren zonder voorafgaande kennisgeving.

u kunt uzelf de trotse eigenaar van dit product noemen. In het geval dat u enige hulp of ondersteuning vereist, aarzel dan niet om contact op te nemen met een van onze dealers.

**Service Department (IB)**

**INTERNATIONAL TRACTORS LIMITED**

**Vill Chak Gujran, P.O. Piplanwala 146022**

**Jalandhar Road, Hoshiarpur, Punjab.**

**Phone: 01882-302-288 / 289 / 299, Fax: 01882-302-555.**

**E-mail: [export@sonalika.com](mailto:export@sonalika.com)**

## UW RECHTEN

Tijdens de afname van een nieuwe "Solis 20" Tractor, kunt U de dealer While taking delivery of new **SOLIS 20 Tractor**, kindly ask the dealer to give following items:

### 1. Tool kit which includes

• Grease Gun (Optional)	1pc
• D-spanner 10x 11	1pc
• D-spanner 12X 13	1pc
• D-spanner 14X 17	1pc
• D-spanner 18X 19	1pc
• D-spanner 20X 22	1pc
• D-spanner 30X 32	1pc
• Ring spanner 16X 17	1pc
• Battery Guarantee card	1pc
• Ring Spanner 24X 27	

### 2. Farmer Kit

Fuel Filter Catridge (703008219a )	3
Oil Filter Assy. 3 Cyl.(803007059a)	2
Fan Belt (703006099a)	1
Linch Pin (10080109ab)	3
Fuel Tank Cap With Key (10071015ac)	1
Tyre Pressure Gauge (10026665aa)	1
Fuses For Farmer Kit (10071358aa)	1
Hose Pipe For Air Cleaner(10051220ba)	1
Cap For Radiator (10026958aa)	1

### 3. To avail the services.

### 4. To call dealers any time for any breakdown.



### 5. Additional Accessories as Standard fitment

- Safety Reflector
- Plough Lamp (1pc) (Optional)
- Rear View Mirror

































## RICHTLIJNEN OVER VEILIGHEIDSTEKENS

### Erken Veiligheid Informatie:

Dit is het waarschuwingssymbool. Elk symbool op uw machine of in deze handleiding, waarschuwt u voor een mogelijke kans om persoonlijk letsel op te lopen. Volg de aanbevolen voorzorgsmaatregelen en een veilige bedrijfsvoering.

 <p><b>DANGER</b></p> <p>Dit symbool en het woord "DANGER" duiden op een onmiddellijke gevaarlijke situatie, die indien niet vermeden, zal leiden tot de DOOD of ZEER ERNSTIG LETSEL.</p>	<ol style="list-style-type: none"><li>1. Bescherm uw gezicht van een radiator onder druk als de motor warm is. Verwijder de dop voorzichtig en alleen als de motor koud is.</li><li>2. Laat nooit kinderen of onbevoegden uw tractor bedienen, en houd anderen altijd op afstand wanneer het apparaat in werking is.</li></ol>
 <p><b>WARNING</b></p> <p>Dit symbool en het woord "WARNING" duiden op een potentieel gevaarlijke situatie. Als de instructies of procedures niet correct gevolgd worden kan dit leiden tot de DOOD of ZEER ERNSTIG LETSEL</p>	<ol style="list-style-type: none"><li>1. Verwijder nooit de "Danger", "Warning", en "Caution" of instructie labels.</li><li>2. Een exploitant mag nooit onder invloed zijn van drank of drugs, die zijn alertheid of coördinatie beïnvloeden.</li><li>3. Nooit staan of toestaan dat iemand anders op of tussen de tractor en het werktuig staat, tenzij de motor is uitgeschakeld, de versnelling in neutraal staat, en alle uitrusting of werktuigen zijn neergelaten op de grond.</li><li>4. Ontkoppel nooit de koppeling en probeer niet te schakelen, wanneer u een helling afrijdt.</li><li>5. Overbelasting is altijd gevaarlijk. Controleer dus altijd het laadvermogen van uw tractor en overbelast deze nooit.</li><li>6. Koppel nooit de hydraulische aansluitingen los en pas nooit een werktuig aan met een draaiende motor of de aftakas in werking. Dit zou kunnen leiden tot ernstig letsel of de dood.</li></ol>
 <p><b>CAUTION</b></p> <p>Dit symbool en het woord "Caution" duiden op een potentieel gevaarlijke situatie, die indien niet vermeden, kan leiden tot LICHT LETSEL.</p>	<ol style="list-style-type: none"><li>1. Laat een lopende tractor nooit ongestuurd achter, en houd ten alle tijden een stevige grip op het stuur.</li><li>2. Voordat u van de tractor afstapt, wordt u geacht de aftakas te ontkoppelen, alle uitrusting en werktuigen neer te laten, de versnelling in zijn neutraal te zetten, de handrem aan te trekken, de motor uit te zetten en de sleutel te verwijderen.</li><li>3. Rook niet tijdens het tanken van de tractor, en houd elke vorm van open vuur weg.</li></ol>

## ROAD SAFETY SIGNS

 Rechtse bocht	 Linkse bocht	 Right Hand Pin Bend	 Left Hand Pin Bend	 Narrow Bridge	 Pedestrian Crossing
 School Ahead	 Men at Work	 Cross Road	 Gap in Median	 Side Road Right	 Side Road Left
 Staggered Intersection	 No Parking		 No Stopping or Standing		 Staggered Intersection
 Major Road Ahead	 Major Road Ahead	 Right Reverse Bend	 Left Reverse Bend	 Narrow Road Ahead	 Road Widens Ahead
 Cattle	 Ferry	 One Way Signs Vehicles Prohibited in One Direction		 One Way Signs Vehicles Prohibited in One Direction	
 Y-Intersection	 T-Intersection	 Straight Prohibited or No Entry	 Right Turn Prohibited	 Left Turn Prohibited	 U-turn Prohibited



## VEILIG GEBRUIK

Voorzichtig gebruik is uw beste verzekering tegen ongelukken.

Lees deze gebruiksaanwijzing aandachtig door, voordat u de tractor bestuurd.

Alle gebruikers, ongeacht de desbetreffende ervaring, worden geacht deze gebruiksaanwijzingen te lezen voordat men gebruik maakt van de tractor.

Het is de eigenaar zijn verplichting om elke verdere gebruiker in te lichten over het veilige gebruik van de tractor.

### 1. VOOR HET GEBRUIK VAN DE TRACTOR

#### LEES DE VEILIGHEIDSINSTRUCTIES

Lees de veiligheidsinstructies in deze gebruiksaanwijzing aandachtig door. Het nalaten van een van de volgende veiligheidsovereenkomsten kan leiden tot erge verwondingen of de dood. Houd alle veiligheidstekens in goede conditie, en vervang beschadigde of kapotte veiligheidstekens.

Houd uw tractor in goede conditie en sta ongeautoriseerde wijzigingen aan uw tractor niet toe, wat de werking, veiligheid, en levensduur van uw tractor kan beïnvloeden.

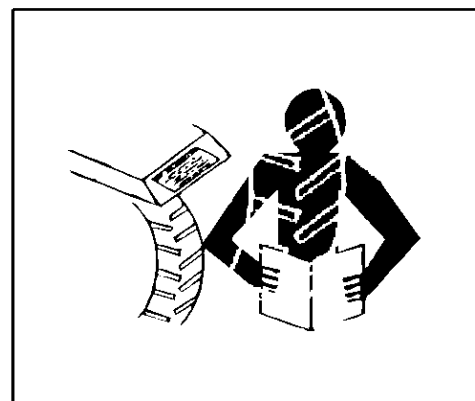

#### • Het besturen van de tractor

1. Kijk uit waar je rijdt vooral bij het einde van rijen, op wegen, bij bomen en andere bij andere obstakels.
2. Voorkom tegenslagen, door de tractor zorgvuldig te besturen en een veilige snelheid aan te houden. Dit geldt voornamelijk bij het werken op ruw terrein en hellingen, het oversteken van sloten, en bij het maken van bochten
3. Vergrendel beide rempedalen van de tractor, wanneer de tractor wordt getransporteerd over wegen.
4. Houd de tractor in dezelfde versnelling wanneer u bergafwaarts gaat als bij het bergop rijden, en ga nooit bergafwaarts zonder dat de tractor in zijn versnelling staat.
5. Elk getrokken voertuig of aanhangwagen waarvan het totale gewicht hoger is dan het gewicht van de trekkende tractor, moet worden uitgerust met eigen remmen voor een veilig gebruik.
6. Wanneer de tractor vast raakt of wanneer deze is vast gevoren aan de grond, **back out to prevent upset.**
7. Kijk met het rijden en vooral met het vervoeren van de tractor ook altijd naar de desbetreffende toegestane hoogte op de weg.

## VEILIGHEIDS TIPS TIJDENS ONDERHOUD

1. Check dagelijks het oliepeil, het waterpeil in de radiator en de accu op genoeg vermogen, en verricht het onderhoud volgens de onderhoudsinstructies.
2. Zorg altijd voor een gelijke en correcte bandenspanning voor de desbetreffende uitgevoerde taken.
3. Kijk altijd goed na of alle bedieningselementen en aansluitingen van de tractor en het desbetreffende werktuig correct zijn aangesloten en naar behoren werken.
4. Zorg ervoor dat er altijd voldoende gereedschap aanwezig is voor het verrichten van onderhoud en kleine reparaties.
5. Zorg er altijd voor dat onderhoud en reparaties aan de tractor worden uitgevoerd op een vlakke en harde ondergrond.

Voer geen onderhoudswerkzaamheden uit aan de tractor totdat deze is uitgeschakeld, de handrem is aangetrokken en de wielen zijn geblokkeerd. Wanneer de tractor in een gesloten ruimte wordt onderhouden, zorg er dan voor dat de ruimte goed wordt geventileerd wanneer de motor aan staat, omdat de uitlaatgassen schadelijk zijn en uiteindelijk kunnen leiden tot de dood.

6. Werk nooit onder opgeheven werktuigen of wanneer werktuigen nog in werking zijn.
7. Zorg ervoor dat bij het verwisselen van de wielen of banden, er een geschikt standaard onder de as van de tractor is geplaatst en de wielen zijn geblokkeerd voordat het desbetreffende wiel of band is verwijderd.
8. Wanneer afschermende onderdelen die dienen voor diens bescherming tijdens het gebruik van de tractor verwijderd moeten worden voor onderhoud of reparatie, zorg er dan altijd voor dat u deze afschermende onderdelen weer op de desbetreffende manier installeert voordat u gebruikt maakt van de tractor.
9. Tank nooit in de buurt van een open vlam of een oververhitte motor. En zorg er altijd voor dat u de motor heeft uitgeschakeld voor het tanken.
10. Het koelsysteem van de tractor werkt onder druk. Zorg bij het verwijderen van de radiator dop dat de motor is afgekoeld, om brandwonden veroorzaakt door stoom of heet water te voorkomen. Voeg ook nooit water toe in de radiator wanneer de motor warm is, maar zorg ervoor dat u wacht tot deze volledig is afgekoeld.
11. Om ontvlaming te voorkomen, zorg er dan ten alle tijden voor dat u de tractor en motor schoon houdt en ontvlambaar materiaal en brandstoffen verwijderd.

## BESCHERMING VAN KINDEREN

Houdt kinderen en onbevoegden uit de buurt van de tractor indien in werking.

- Kijk voordat u achteruit rijdt naar achter of het vrij is van obstakels.
- Laat kinderen en onbevoegden nooit de tractor of een werktuig besturen.



## VOORZORGSMAATREGELEN OM KANTELEN TE VOORKOMEN

Rijd niet op plekken waar de tractor mogelijk kan wegglijden of omvallen.

Blijf altijd alert voor gaten en andere obstakels.

Verlaag je snelheid bij het maken van scherpe bochten.

Het voorwaarts weggrijden uit een greppel of verzakking kan er voor zorgen dat de tractor naar achter kantelt. Voorkom dit ten alle tijden.

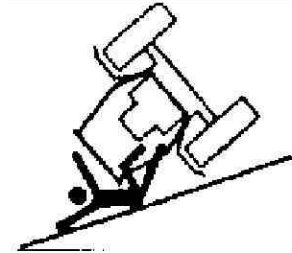

## PARKEER DE TRACTOR VEILIG

Nadat u gebruik heeft gemaakt van de tractor:

- Laat alle werktuigen zakken.
- Stop de motor en haal de sleutel uit het contact.

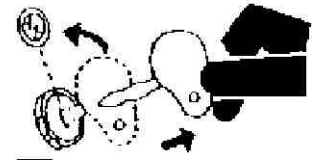

## HOUD PASSAGIERS VAN DE TRACTOR

Sta geen mede-inzittende toe op de tractor.

Mede-inzittende kunnen zwaar gewond raken door beknelling, bewegende onderdelen, of het vallen van de tractor.

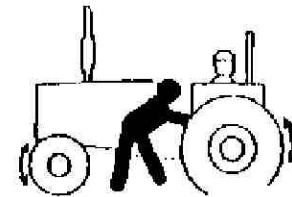

## VEILIG TANKEN EN VOORKOM BRAND

Behandel brandstof met adaat u gebruik heeft gemaakt van de tractor:

- Laat alle werktuigen zakken.
- Stop de motor en haal de sleutel uit het contact.



## STAY CLEAR OF ROTATING SHAFTS

Entanglement in rotating shaft can cause serious injury or death.

Keep PTO shield in place at all times.

Wear close fitting clothing. Stop the engine and to sure PTO drive is stopped before making adjustments, connections, or cleaning out PTO driven equipment.



### ALWAYS USE SAFETY LIGHTS AND DRIVES

Use of hazard warning lights and turn signals are recommended when towing equipment on public roads unless prohibited by state or local regulations. Use slow moving vehicle (SMV) sign when driving on public road during both day & night time, unless prohibited by law.

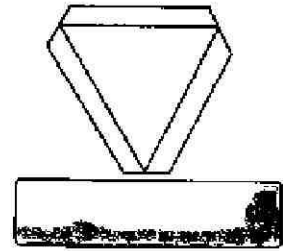

### PRACTICE SAFE MAINTENANCE

Understand service procedure before doing work.  
Keep the surrounding area of the Tractor clean and dry.  
Do not attempt to service Tractor when it is motion.  
Keep body and clothing away from rotating shafts.  
Always lower equipment to the ground. Stop the engine.  
Remove the key equipment to the ground. Stop the engine.  
Securely support any Tractor elements that must be raised for service work.  
Keep all parts in good condition and properly installed.  
Replace worn or broken parts. Replace damage/missing decals.  
Remove any buildup of grease or oil form the Tractor.  
Disconnect battery ground cable (–) before making adjustments on electrical system or welding on Tractor.



### AVOID HIGH-PRESSURE FLUIDS

Escaping fluid under pressure can penetrate the skin causing serious injury. Keep hands and body away from pinholes and nozzies, which eject fluids under high pressure. If ANY fluid is injected into the skin. Consult your doctor immediately.



### PREVENT BATTERY EXPLOSIONS

Keep sparks, lighted matches, and open flame away from the top of battery.  
Battery gas can explode.  
Never check battery charge by placing a metal object across the poles.

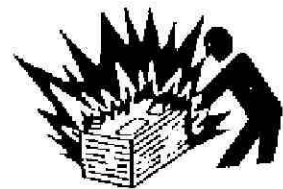

### SERVICE TRACTOR SAFELY

Do not wear a necktie, scarf or loose clothing when you work near moving parts. If these items were to get caught, severe injury could result.  
Remove rings and other jewelry to prevent electrical shorts and entanglement in moving parts.

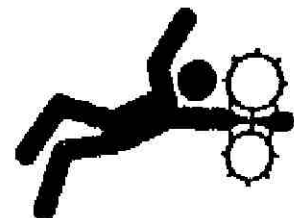



### PREVENT ACID BURNS

Sulfuric acid in battery electrolyte is poisonous. It is strong enough to burn skin, cause holes in clothing and cause blindness if found entry into eyes.

For adequate safety always.

1. Fill batteries in a well-ventilated area.
2. Wear eye protection and acid proof hand gloves
3. Avoid breathing direct fumes when electrolyte is added.
4. Do not add water to electrolyte as it may splash off causing server burns.

If you spill acid on your self.

1. Flush your skin with water.
2. Flush your eyes with water for 10-15 minutes.

Get medical attention immediately.

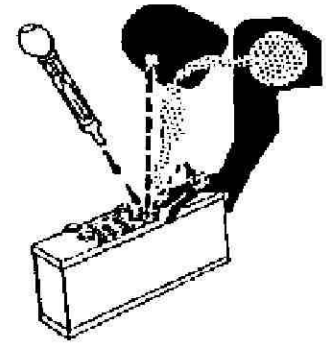

### WORK IN VENTILATED AREA

Do not start the Tractor in an enclosed building unless the doors & windows are open for proper ventilation, as tractor fumes can cause sickness or death. If it is necessary to run an engine in an enclosed area remove the exhaust fumes by connecting exhaust pipe extensions.



### TRACTOR RUNAWAY

1. The tractor can start even if the transmission is engaged position causing Tractor to runaway and serious injury to the people standing nearby the tractor. For additional safety keep the pull to stop knob (fuel shut off control) in fully pulled out position.

Transmission in neutral position. Foot brake engaged and PTO lever in disengaged position while attending to Safety Starter Switch or any other work on Tractor.

### SAFETY STARTER SWITCH

1. Clutch operated safety switch is provided on all Tractors which allow the starting system to become operational only when the Clutch pedal is fully pressed.
2. Do not By-pass this safety switch or work on it. Only Authorized Dealers are recommended to work on safety starter switch.



Safety Starter Switch is to be replaced after every 2000 hours/4years, whichever is earli

# CONTENTS

S.No.	DESCRIPTION	PAGE NO.
1.	IDENTIFICATION OF TRACTOR.....	19
2.	INTRODUCTION & DESCRIPTION.....	20
3.	OPERATIONS.....	21
	<b>3.1 Instrumental Panel.....</b>	<b>22</b>
	Temperature Gauge.....	22
	Engine Oil Pressure Indicator.....	22
	RPM cum Hour Recorder.....	23
	Fuel Gauge.....	23
	Battery Charge Indicator.....	23
	High Beam Indicator.....	23
	Left Side Indicator.....	23
	Right Side Indicator.....	24
	PTO Lever Position Indication.....	24
	Gear Lever Position Indication.....	24
	<b>3.2 Electrical Control :.....</b>	<b>25</b>
	Hazard Light Switch.....	25
	Side Indicator Switch.....	25
	Combination Switch.....	25
	Starting Key Switch.....	26
	Engine Stop Knob.....	26
	Fuse Box.....	26
	Revolving light Switch.....	26
	<b>3.3 Electrical Equipments.....</b>	<b>27</b>
	Battery & its Maintenance.....	27
	Alternator.....	27
	V-Belt Checking and Adjustment.....	27
	Starter Motor.....	27
	General Maintenance of Electrical System.....	28
	Precautions before Connecting Welding Apparatus.....	28
	<b>3.4 Sheet Metal :.....</b>	<b>28</b>
	Procedure to open the Top Hood.....	28
	<b>3.5 Controls :.....</b>	<b>29</b>
	Main Gear Shifter Lever.....	29
	High -Low Lever.....	29
	2WD/4WS Lever.....	29
	Power Take Off Shifter Lever.....	30
	Differential Lock Pedal.....	30
	Clutch Pedal.....	30
	Method to Check the Clutch Pedal Free Play.....	30

<b>S.No.</b>	<b>DESCRIPTION</b>	<b>PAGE NO.</b>
	Foot Brake Pedal.....	30
	Method for Check Brakes.....	30
	Parking Brake.....	31
	Foot Accelerator.....	31
	Hand Throttle Lever.....	31
	Driver Seat.....	31
	Travel Adjustment.....	31
	Back Adjustment.....	31
	Tool Box.....	31
	Seven Pin Socket.....	32
	Position Control Lever.....	32
	Power Take Off.....	32
	Registration Plate.....	32
	Lights.....	32
<b>3.6</b>	<b>Engine.....</b>	<b>33</b>
	Starting the Engine.....	33
	Proceed as Follows.....	33
	Running the Engine.....	34
	Turning Off the Engine.....	33
<b>3.7</b>	<b>Fuel System :.....</b>	<b>34</b>
	Fuel Saving Tips.....	34
<b>3.8</b>	<b>Hydraulic :.....</b>	<b>35</b>
	Hydraulic System.....	35
	Response Valve.....	35
	Three Point Linkage.....	35
	Quick Release coupling.....	35
	Directional Control Valve.....	35
<b>3.9</b>	<b>Wheel and Tyres :.....</b>	<b>36</b>
	In field operations.....	36
	In Road Operations.....	36
	Recommended Load carrying Capacity.....	36
	Ballasting of Tractor.....	37
	Front Wheel TOE IN.....	37
	Checking and Adjustment of TOE IN.....	37
	Rear Wheel Track Width Adjustment.....	38
	General Suggestions.....	38
	Check Wheel Nut Bolt.....	38

S.No.	DESCRIPTION	PAGE NO.
<b>4.</b>	<b>GENERAL MAINTENANCE</b>	<b>39</b>
<b>4.1</b>	<b>Engine</b>	<b>39</b>
	Engine Lubrication System	39
	Check Engine Oil Level	39
	Changing of Engine Oil & Oil Filter	39
	Replacement of Fuel Filter	40
	Air Bleeding From Fuel Injections System/Fuel Filter Replacement	40
<b>4.2</b>	<b>Air Cleaner</b>	<b>40</b>
	Oil bath type air cleaner	40
	Cleaning of pre cleaner (Dry)	40
	Air cleaner bowl & element cleaning (wet)	41
	After every 50 hrs	41
<b>4.3</b>	<b>Radiator</b>	<b>42</b>
	Coollant Level in Radiator (Hot)	42
	Radiator Draining and Flushing (When Cold)	42
	Radiator Fins Cleaning	42
	Radiator Cap	42
<b>4.4</b>	<b>Hydraulic</b>	<b>43</b>
	Transmission/Hydraulic Oil Level	43
	Change Transmission Oil	43
	Change Steering Gear Box Oil	43
	Checking Specification Gravity of Battery Electrolyte	43
	Front Axie Oil Level	43
<b>5.</b>	<b>Others</b>	<b>44</b>
	Technical Parameters	44
	Recommended Grade of Lubricants and greases	47
	Service Schedule	48
	Greasing Points	49
	Wiring Diagram	50
	Warranty	51
<b>6.</b>	<b>Do'S AND DON'TS</b>	<b>52</b>
<b>7.</b>	<b>TRACTOR INSTALLATION CERTIFICATE</b>	<b>56</b>
<b>8.</b>	<b>FREE SERVICE COUPONS</b>	<b>59</b>
<b>9.</b>	<b>TROUBLE SHOOTING</b>	<b>67</b>
<b>10.</b>	<b>MATCHING IMPLEMENT</b>	<b>69</b>
	<b>Specifications</b>	<b>69</b>
	<b>Cultivator</b>	<b>69</b>
	<b>Rotavator</b>	<b>70</b>
<b>12.</b>	<b>SERVICE RECORD</b>	<b>75</b>
<b>13.</b>	<b>NOTES</b>	<b>76</b>

# 1. IDENTIFICATION OF TRACTOR

**Solis 20, Homologation Certificate  
E11\*2010/22\*0209\*00  
Revision 00 issued by the vehicle  
certification agency on the approval  
authority in the United Kingdom**

Serial No.	Mfg. Date
<input type="text"/>	<input type="text"/>
	
Model	<input type="text"/>
S16R-	<input type="text"/>
Rated Output	<input type="text"/> / <input type="text"/> rpm
	<input type="text"/> / <input type="text"/> rpm
<b>MITSUBISHI</b> HEAVY INDUSTRIES LTD. SAGAMIHARA, JAPAN	



ROPS Certificate Plate

SV <sub>1</sub>	INTERNATIONAL TRACTORS LIMITED
e11	TRACTOR TYPE T 2
3003	Serial No. <input type="text"/>
Tractor Model	Solis 20 4WD

**SOLIS**

## 2. INTRODUCTION & DESCRIPTION

### TRACTOR AN INTRODUCTION

The word, 'Tractor' has been derived from 'Traction' which means pulling.

A Tractor is required to pull or haul an equipment, implement or trolley which are coupled to the Tractor body through suitable linkage. A Tractor can also be used as a prime mover as it has power outlet source which is also called Power Take off or PTO shaft.

In this book the operating, maintenance and storage instructions for Solis-20 Tractor has been complied. This material has been prepared in detail to help you in the better understanding of maintenance and efficient operation of the machine.

If you need any information not given in this manual or require the services of a trained machanics, please get in touch with the ITL Dealer/Distributor in your locality, Dealer/Distributors are kept informed of the latest methods of servicing Tractors. They stock genuine spare parts and are backed by the Company's full support.



**(Front, Rear, Left, Right Portion)**

Through this manual. The use of the terms LEFT, RIGHT, FRONT and REAR must be understood, to avoid any confusion when following the introductions. The LEFT and RIGHT means left and right sides of the Tractor when facing forward in the driver's seal, Reference to the FRONT indicates the radiator end of the Tractor, while the REAR, indicates the drawbar end.

When spare parts are required, always specify the Tractor and engine serial number when ordering these parts. This will facilitate faster delivery and help ensure that the correct parts of your particular Tractor serial number is punched on a plate attached to the left hand side of the engine body. For easy reference, we suggest you to write the number in the space provided in the owner's personal data.

### 3. OPERATIONS

#### 3.1 INSTRUMENT PANEL

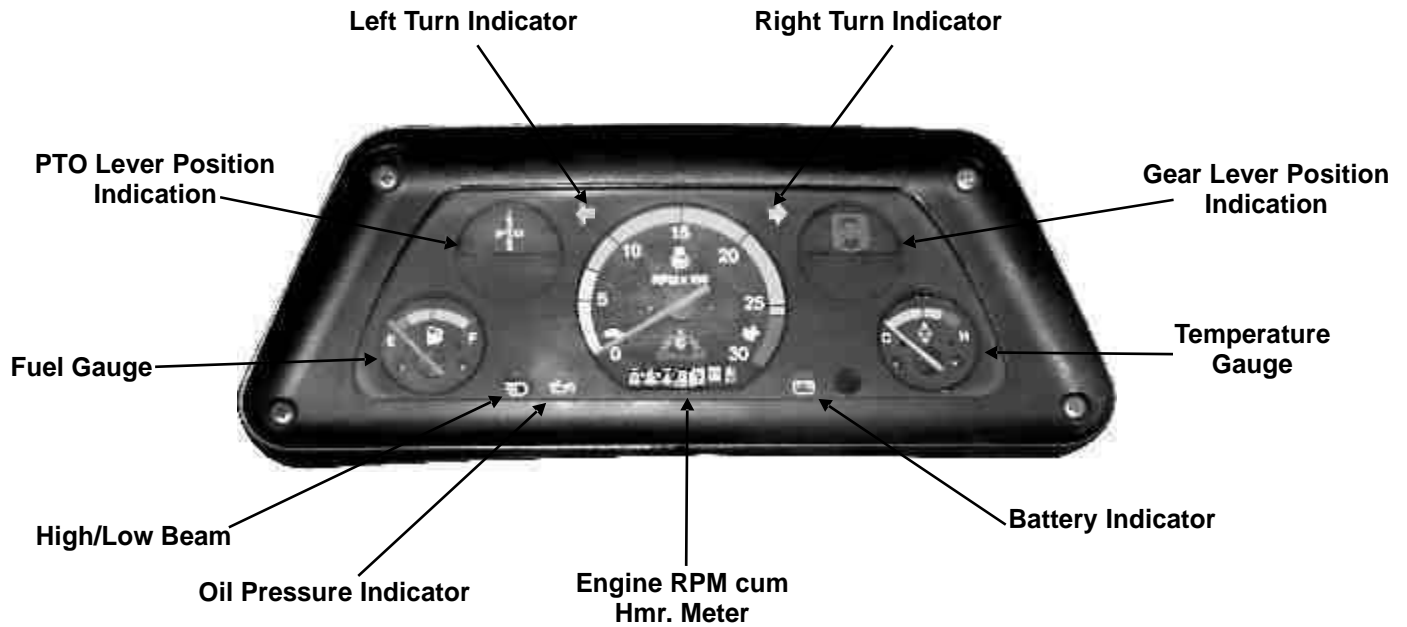

#### 3.2 ELECTRICAL CONTROLS

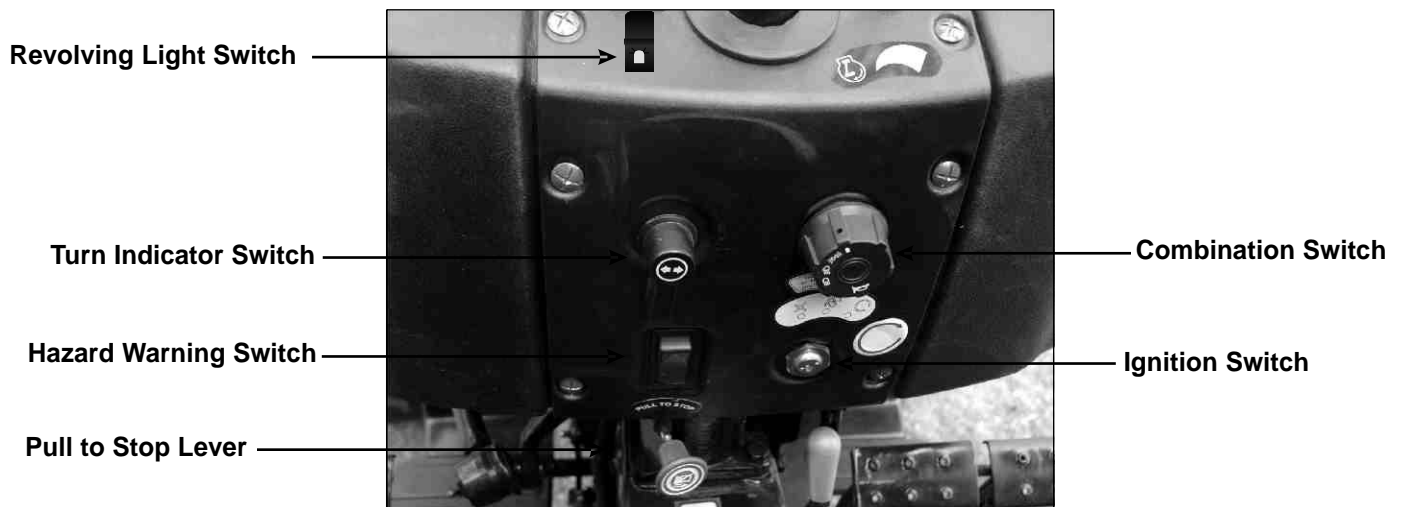

### 3.1.1 TEMPERATURE GAUGE :

This gauge indicates temperature of engine coolant, GREEN zone indicates normal temperature and RED Zone indicates engine overheating. If the needle moves beyond normal range, towards RED zone, follow the procedure.

1. Drive safely to the side of road and stop your tractor.
2. Allow the engine to run idle.
3. If the temperature does not go down, shut it off and allow sufficient time for it to cool.
4. Visually inspect the fan belt for looseness, breakage and all water hose connections for leak.
5. If the fan belt is OK and no coolant leak is noticed check the coolant level.
6. Add coolant if required otherwise contact your nearest dealer.

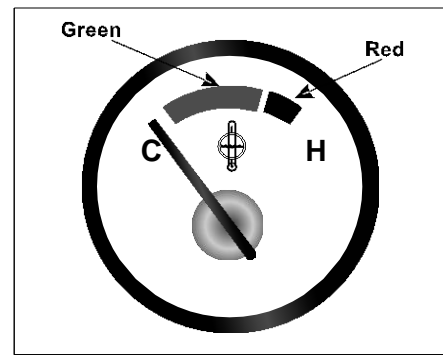

**WARNING**

Do not remove the radiator cap when the engine and radiator are hot. Boiling hot coolant and steam may blow out under pressure, which could cause serious injury. The cap should only be taken off when the coolant temperature has lowered.

Necessary precaution to be taken while opening the radiator cap.

### 3.1.2 ENGINE OIL PRESSURE INDICATOR

This indicator indicates pressure of lubricating oil in the engine. If the indicator glow, stop the engine and follow the procedure :

1. Stop your tractor to the side of road on leveled surface.
2. Wait for sufficient time after stopping the engine to get down the oil from gallery to oil sump.
3. Pull out the dipstick, wipe off oil with a clean cloth.
4. Insert the dipstick, fully into the oil level gauge guide, then pull out the gauge again. The correct oil level is between the MAX. & Min. marks on the dipstick.
5. If the oil level is low, remove the oil filler cap and add oil of the specified type to the MAX. level.
6. Install the oil filler cap after a topup.
7. Check the oil pan and other parts for oil leakage.
8. Start the engine, allow it to run idle and don't race it immediately if again the red light glows, then contact your nearest dealer.

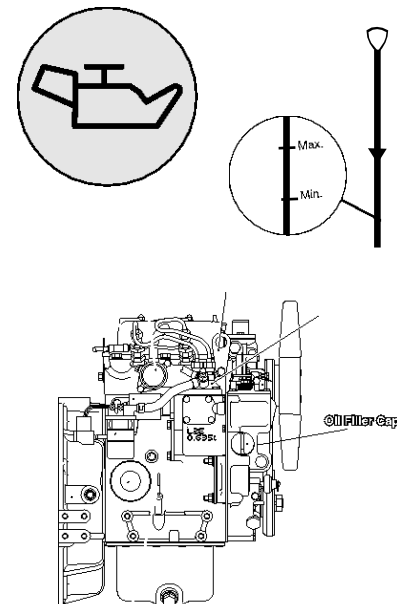

**CAUTION**

Do not operate the engine if there is no oil pressure indication.



### 3.1.3 RPM CUM HOUR RECORDER

Needle of this meter indicates speed of engine in revolution per minute and the recorder meter indicates the number of hours clocked by the engine.

Green Zones is safe for operation.

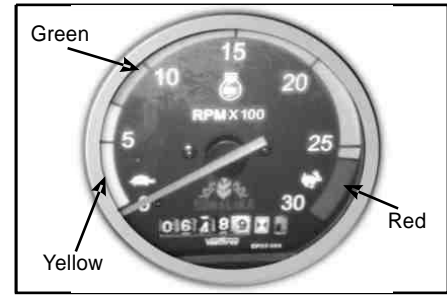

### 3.1.4 FUEL GAUGE

Fuel gauge gives an approximate indication of the quantity of fuel in fuel tank. If the needle enters in RED zone, refill the fuel tank.

Ensure Min. 5 Ltr. of Fuel in Fuel Tank to avoid air locking

Fuel Tank Capacity 30 Ltr.



### 3.1.5 BATTERY CHARGE INDICATOR

This indicator indicates that either battery is being charged or not. Refer the below given observations with respect to different

CONDITIONS			Battery Charging System Functioning
IGNITION SWITCH	ENGINE	INDICATOR	
ON	OFF	GLOW	OK
ON	OFF	OFF	Charging System/Battery is defective, Get both thing checked from electrician
ON	Start/Running	OFF	Battery being Charged
ON	Start/Running	GLOW	Charging System is defective/Battery is draining out, get the charging system checked from electrician.

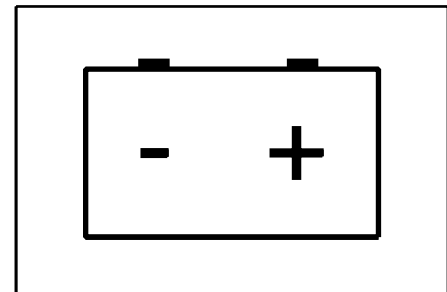

### 3.1.6 HIGH BEAM INDICATOR

This blue light glows when Head Lights are in high beam mode.



### 3.1.7 LEFT SIDE INDICATOR

It glow when the left side indicator is switched ON



### 3.1.8 RIGHT SIDE INDICATOR

It glow when the right side indicator is switched ON



### 3.1.9 PTO LEVER POSITION INDICATOR

This is only for awareness about Positions of PTO Lever to get 3-Speeds i.e. C1, C2, C3.

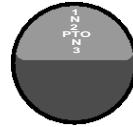

### 3.1.10 GEAR LEVER POSITION INDICATOR

This is only for awareness about Positions of Gear Lever to select the desired gear speed.

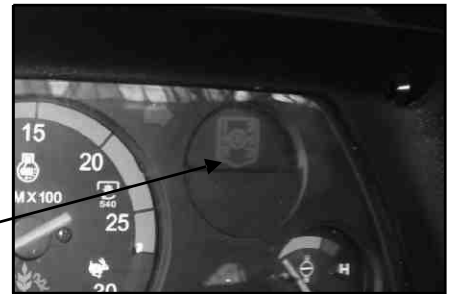
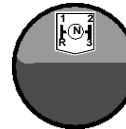

## 3.2 ELECTRICAL CONTROLS

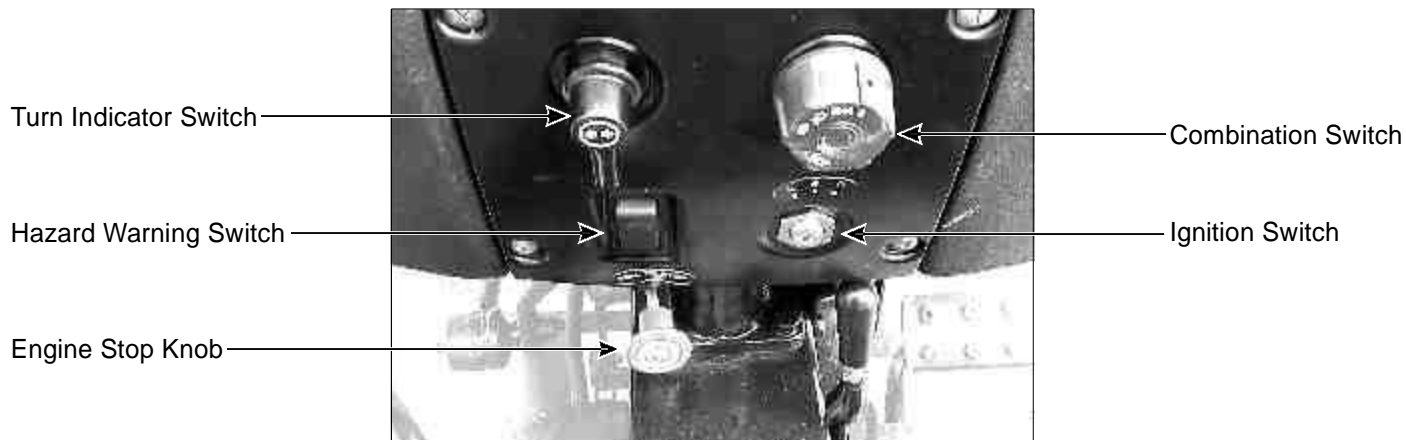

### 3.2.1 HAZARD LIGHT SWITCH:

Purpose of the hazard switch is as follows.

1. All the four lights blinking Indicates that driver has no control on tractor.
2. Mechanical defects in the tractor.

Push this switch to blink all indicators in HAZARD situation to alert others.



### 3.2.2 SIDE INDICATOR SWITCH:

This switch is used for indicating the vehicle turn. Move turn signal lever left to indicate left hand turn or right for right hand turn. Indicator lights in cluster will flash accordingly.

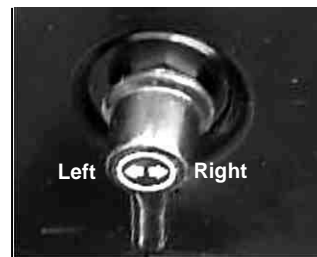

### 3.2.3 COMBINATION SWITCH:

This switch illuminates all lights (Parking Light, Head Light, High Beam, Low Beam) with the clockwise rotation as well act as horn switch.

**HORN** : Press the combination switch to blow the Horn.

<p><b>OFF Position</b> All lights are off.</p>	<p><b>1st Position (Clockwise)</b> With 1st click Stop parking lights, Instrument panel lights and tail lights will glow.</p>	<p><b>2nd Position (Clockwise) :</b> With 2nd click Stop Head lights (Low beam), Instrument panel lights, Parking lights and tail light will</p>	<p><b>3rd Position (Clockwise) :</b> With 3rd click Stop Head lights (High beam) Instrument panel lights, Parking lights and tail light will glow.</p>	<p><b>Horn :</b> Press the combination switch to blow the Horn.</p>
--	---	--	--	---

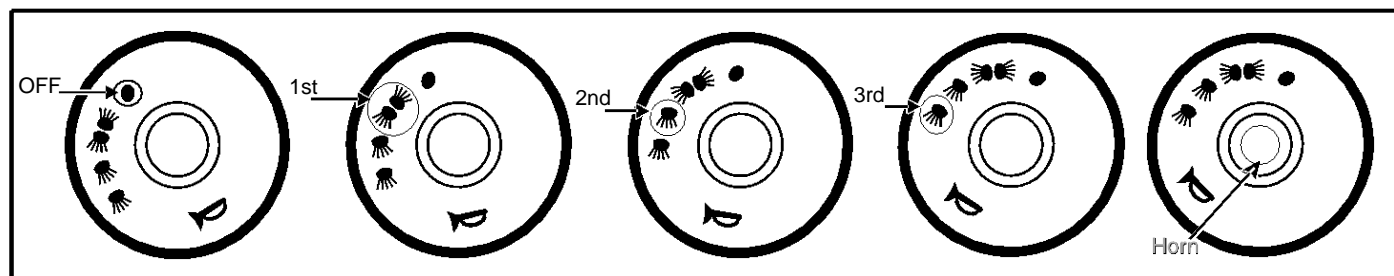

### 3.2.4 STARTING KEY SWITCH:

Functioning of starting key switch is as below:

**1st Position (OFF) :** All the electrical systems remain disconnected in this position.

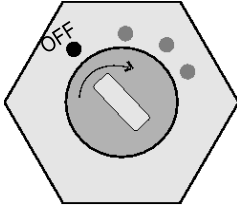

**2nd Position (ON) :** The warning lights (Battery, Oil Pressure indicator & other Cluster Lights) will be functional in this position. This is normal running position after the engine is started.

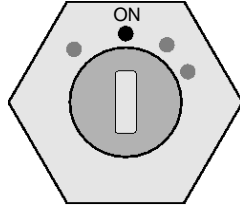

**3rd Position (Use of Heater):**

Turn the key slightly clockwise and hold in between ON & START position for 3-5 Seconds so that glow plugs can heat up the air in the cylinders.

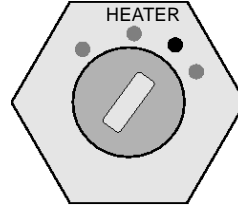

**4th Position (START):** Immediate after the use of air heater turn the key further clockwise to Start position to start the engine.

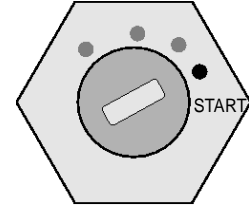

**NOTE :**

- Do not keep the starter engaged more than 5-8 seconds. If engine stalls/fails to start then wait for 5-10 seconds before re-engaging the starter, otherwise you may damage it.
- Keep the switch in OFF condition when engine is also in OFF condition.

### 3.2.5 ENGINE STOP KNOB:

To stop the engine release the accelerator lever and pull the stopping knob. After stopping the engine push it back to its original position.



### 3.2.6 FUSE BOX:

Fuse box is mounted under the right side of Fuel Tank. If an electrical failure occurs, check for a blown fuse and replace with specified fuse only.



**CAUTION:** Never install a wire instead for proper fuse.

### 3.2.7 Revolving Light Switch

Revolving light as show in the figure is used as the precession light during working of the tractor in the field. ON/OFF switch is located on dash board in control figure.



### 3.3 ELECTRICAL EQUIPMENTS

#### 3.3.1 BATTERY AND ITS MAINTENANCE

12,V, 50 AH is mounted at front of the tractor.

##### 1. CHECK ELECTROLYTE LEVEL

It must be as per the recommendation of battery manufacturer.

If required top up with distilled water. Never add acid.

##### 2. CHECK CAREFULLY BATTERY CHARGING

Protect against freezing. Insure that terminals are clean and tight. Check electrolyte battery charge. This operation is carried out using a battery hydrometer. The value of a fully charged electrolyte is 1265. If below 1215 recharge the battery.

##### 3. PRECAUTIONS

1. The electrolyte in the battery contains sulphuric acid. Which is dangerous and burn the skin take all necessary precautions (protective clothing)
2. If accidentally splash yourself with acid, take care not to breath in the fumes, rinse thoroughly and consult a doctor immediately.
3. Keep the battery well away from any naked flame or sparks

#### 3.3.2 ALTERNATOR

Alternator is fitted on Left side of engine and generates current which charges battery for healthy electrical back up.

Rating: 12V, 30A

#### 3.3.3 V-BELT CHECKING AND ADJUSTMENT

##### CHECKING:

1. Ensure for V-Belt free from defects such as wear, cuts or surface separations, otherwise replace with genuine specified belt.
2. Inspect belt tension as instructed below:  
Push the belt downward with approx. 98 N (10kgf) (22lbf) force midway otherwise adjust the belt tension

##### ADJUSTING :

1. Removal belt cover the covers V-belt.
2. Loosen all retaining bolts of the alternator and adjusting plate.
3. Insert a bar between the alternator and cylinder block and use leverage to move that alternator to have proper v-belt tension.
4. While V-belt tension is appropriate, retighten all the retaining bolts of the alternator and adjusting plate.
5. Reinstall the belt cover.

#### 3.3.4 STARTER MOTOR

Starter motor is mounted on the left side of the engine.

- The starting motor rotates the engine crankshaft for starting.
- Capacity and Rating: 12V, 1.8KW

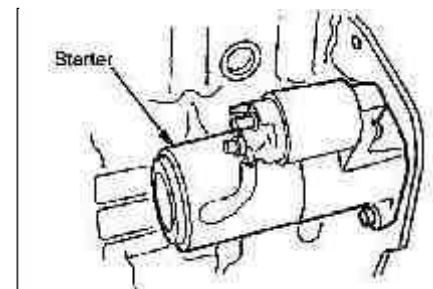
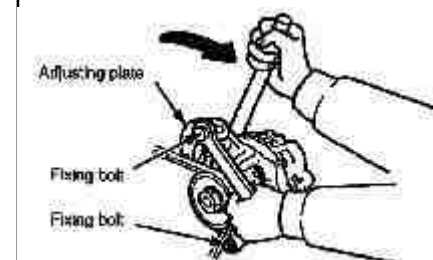
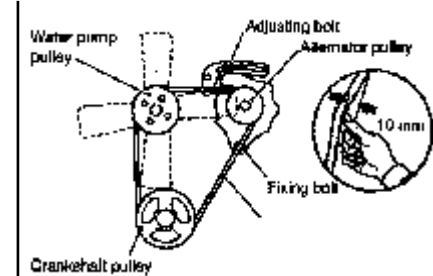
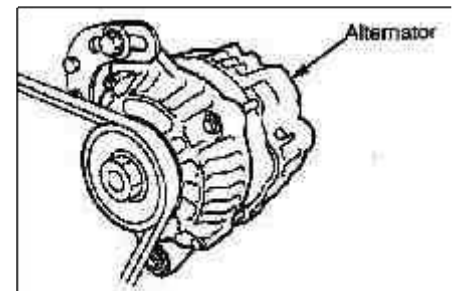
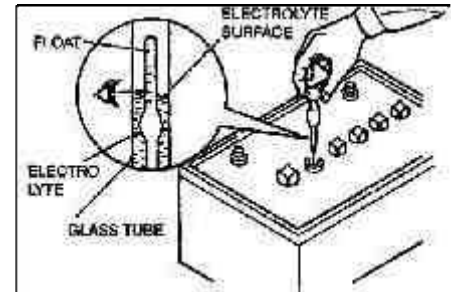
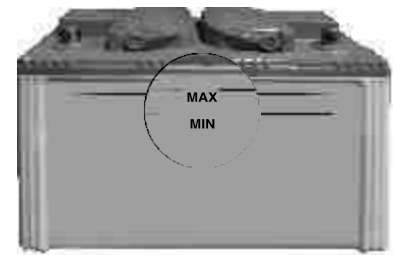

### 3.3.5 GENERAL MAINTENANCE OF ELECTRICAL SYSTEM

- Never Patch up the electrical circuits.
- Never replace a blown fuse by a higher capacity fuse. It could cause a fire.
- Never work on components such as the alternator or starter motor when the engine is running.
- Lastly when you are cleaning the tractor and using the pressure spray, take care not to damage the connections on the various electrical cable.

### 3.3.6 PRECAUTIONS BEFORE CONNECTING WELDING APPARATUS:

- In case of any electrical welding on tractor, first disconnect battery earth connection.

## 3.4 SHEET METAL

### 3.4.1 PROCEDURE TO OPEN THE TOP HOOD

Press the knob (at the centre of the bonnet) towards steering wheel and lift the bonnet upwards to full open position.



## 3.5 CONTROLS

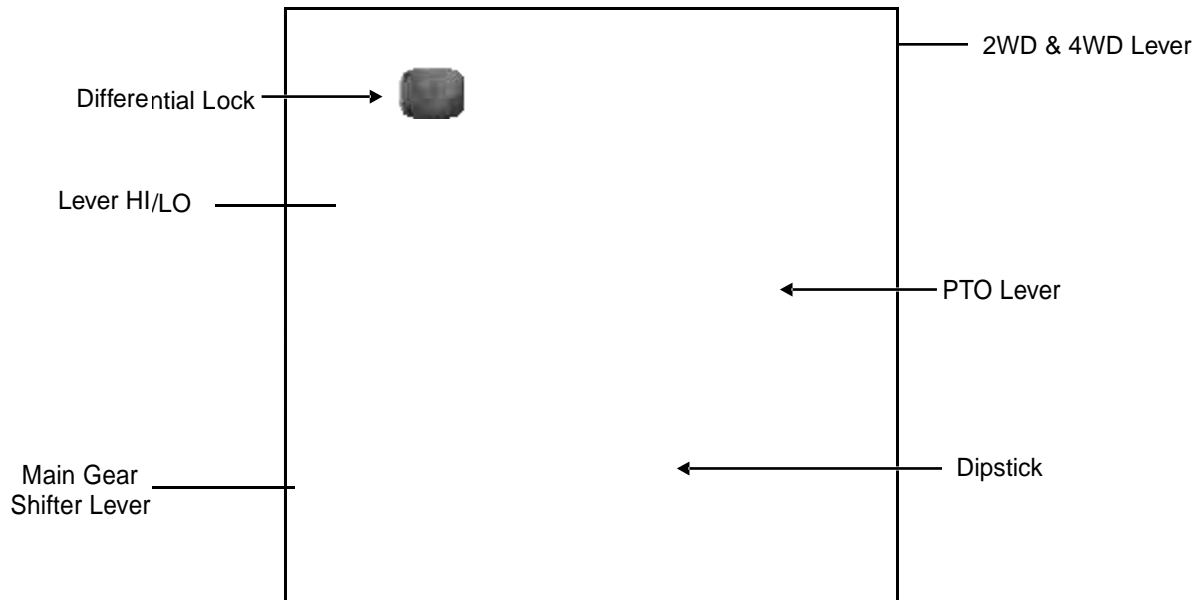

### 3.5.1 MAIN GEAR SHIFTER LEVER

Main gear shifter lever enables to get the required speed (6 Forward and 2 Reverse) by selecting the particular gear with combination of hi-low gear lever. Refer photo for gear shifting arrangements.

Before changing the tractor movement from forward to reverse or reserve to forward direction wait for the tractor to stop.

Release accelerator pedal and declutch. Select required gear, release the clutch gradually and accelerate the engine.



**NOTE:** When traveling downhill always remain in gear. Never declutch. The gear selected should be same as would be used to climb. For engaging/disengaging gear always depress the clutch

### 3.5.2 HIGH-LOW LEVER

This lever is used to change the low speed into high speed or vice versa when tractor is moving. According to requirement you can use it with combination with main gear lever.

Speed Selection:

1. Neutral Position: Lever in the middle cut
2. High Speed: Move the lever out of the cut and shift towards rear end.
3. Slow Speed: Move the lever out of cut and shift towards front end.

Select the speed before tractor movement.

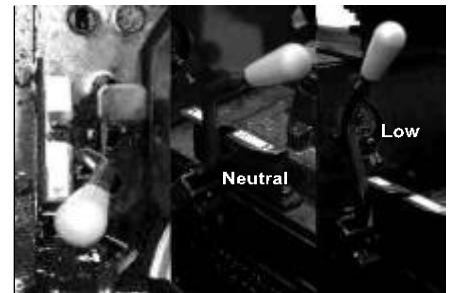

### 3.5.3 2WD/4WD LEVER

This lever decides whether tractor move in 2WD or 4WD mode.

**2WD MODE:** By engaging the lever in 2WD position the power is transmitted to rear wheels only. Shift the lever towards rear (driver seat) to select 2WD mode.

**4WD MODE:** With the lever in 4WD position the power is simultaneously transmitted to all 3 wheels (Front & Rear) of tractor. Shift the lever towards front to select 3WD mode.

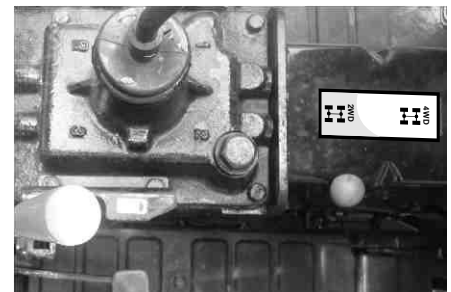

**NOTE:** 4WD Mode is for field operation and 2WD mode is for road running.

### 3.5.4 POWER TAKE OFF SHIFTER LEVER

There are three positions for PTO lever. In the 'N' it is called Neutral position. and other three speed are also selected by shifting this lever to particular position

PTO Lever Position	PTO RPM	@engine rated RPM
1	630	2700
2	930	
3	1605	



### 3.5.5 DIFFERENTIAL LOCK PEDAL

When you press pedal differential lock will work and both the wheel rotate at same speed.

Note : Differential lock operation should be in straight position only and should be disengaged at turnings to avoid any damage of differential assembly.



Do not apply differential lock while tractor speed is more than 6 kmph on turning.

### 3.5.6 CLUTCH PEDAL

By pressing clutch pedal the motion and power of engine will be disengage from gearbox. Release the clutch pedal slowly for transfer the engine power to gear box.

#### 3.5.7 METHOD TO CHECK CLUTCH PEDAL FREE PLAY

Press down the clutch pedal and measure the distance between the footrest and pad. The distance should be 25 to 30 mm. If the distance is less than 25 mm or higher than 30mm then get it adjusted.

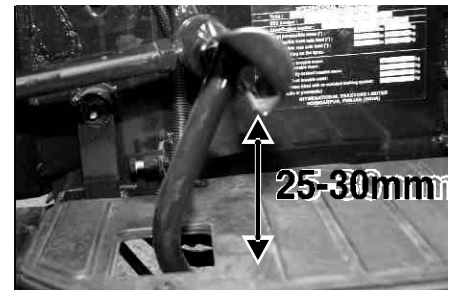

**NOTE:** Do not keep foot on clutch pedal while tractor is in running condition. It may cause excessive wear of clutch and clutch fails before its life time

### 3.5.8 FOOT BRAKE PEDALS

Use independent brake in the field operations. In field you will turn more sharply by pressing brake pedal for the side wheel on the turn. The pedals must be locked for road use.

#### 3.5.9 METHOD TO CHECK BRAKES

Release the hand brake. Uncouple the two pedals

Press down the right hand pedal and measure the distance between the pads & footrest. The distance should be between 25-30 mm.

If the free play is less than 25mm or higher than 30mm then adjust the both hex nut on actuator tie rod until free play comes to 25 to 30 mm. Now, press down the left hand pedal. If the values are not equal with the right hand pedal then repeat the same procedure until values come equal.

NOTE: Ensure locking of both brake pedals while driving on road.

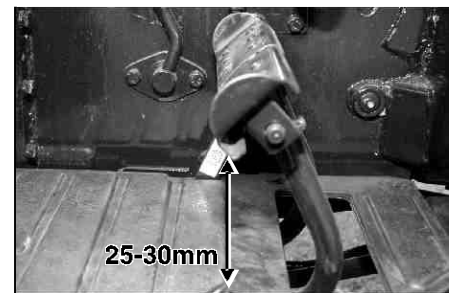

**Note:** Difference in the free play will lead to unbalanced brakes. the tractor can slew, in the event of violent braking. the wheel on which the brakes are applied locks and the tyre wears out quickly. During Road Operations Both the brake Pedals should be locked



### 3.5.10 PARKING BRAKE

Parking brake lever is mounted on R.H.S. footboard and should always be engaged while tractor is parked.

Press the foot break pedal and shift the parking brake lever towards driver seat to engage the parking brake.

Press the foot break pedal and shift the parking brake lever towards front to release the parking brake.



### 3.5.11 FOOT ACCELERATOR

Foot accelerator is used for control the tractor speed as per requirement, Only use foot accelerator while moving on road.

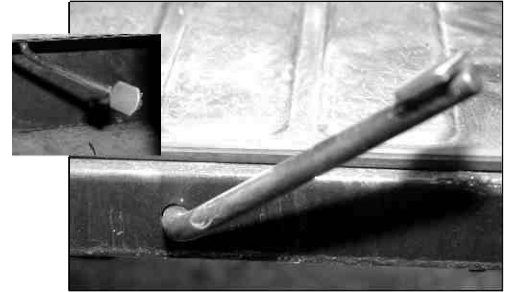

### 3.5.12 HAND THROTTLE LEVER

Hand throttle lever mounted on dashboard (Panel) is used in field application to increase the speed of engine, pull down the lever and to decrease pull up the lever.



### 3.5.13 DRIVER SEAT

Driver seat can be adjusted according to your convenience in following ways

#### 3.5.14 SEAT PAN TRAVEL ADJUSTMENT

Seat can be moved forward & backward to three different locations as per requirement. Adjust the seat as per requirement by shifting the pin as indicated direction .



#### 3.5.15 SEAT BACK ADJUSTMENT

Seat can be adjusted upward/downward by loosening the four bolts mounted on the back side of the seat.

Loose the four mounting screws of seat back. Slide the seat back to desired height and relight the screws.

#### 3.5.16 TOOL BOX

Tool box is mounted at below of driver seat.

To open the tool box tilt the seat towards front then unscrew then knob (A) and lift the cover of tool box.



### 3.5.17 SEVEN PIN SOCKET

7 Pin socket is mounted on backside of driver seat to attach the trailer connection as per following Connectors.

- |                        |                 |
|------------------------|-----------------|
| 1 Earth                | 2 Working light |
| 3 Left Indicator       | 4 Parking light |
| 5 Right Indicator      | 6 Brake light   |
| 7 For Extra Connection |                 |



### 3.5.18 POSITION CONTROL LEVER

This black colour lever is mounted on R.H.S. of driver seat which enables raising or lowering the implement/lift.



### 3.5.19 POWER TAKE OFF

Power take off is mounted at rear side of tractor. This is used for supplying power directly to implement from engine. Power take off shaft has standard 06 Spline on 540 rpm. PTO can be engaged or disengaged by PTO shifter lever. 3 - speeds can be obtained by putting the PTO Lever in different three .Position (i.e. 1,2,3)



### 3.5.20 REGISTRATION PLATE

A vehicle registration plate or number plate is mounted at rear end of right fender as per country rule.



### 3.5.21 LIGHTS

The vehicle is equipped with E marked front and rear tail lights.



### 3.6 Engine:

#### 3.6.1 Starting the Engine:

**Starter Switch:** The starter switch is used to start the engine

##### OFF POSITION

When the key is turned to this position, power supply to the electric circuits is cut off, and the key can be removed or inserted in this position. To stop the engine, turn the key to this position and pull the 'Pull to stop knob'

**ON:** When the key is turned in to this position, power is supplied to the electric circuits. After the engine starts, the key is held in this position.

**HEAT:** This is an intermediate position between the 'ON' and 'Start' position. When the key is turned to this position, the glow plugs would become hot and allow easy startup of a cold engine.

**START:** When the key is turned to this final position, the starter cranks the engine and the engine starts. When the key is released, it automatically returns to the 'ON' position.

##### For Starting:-

- A Check that the gear shifter lever and range selector lever are in neutral.
- B Move the low/ high speed selector lever to neutral position.
- C Move the hand throttle lever to about halfway position.
- D Depress the clutch pedal all the way.

**Warning:** The Engine Should not Crank if the above conditions are not met - If this happens have the tractor repaired by your dealer or authorized service center.

Cold Weather starting (Temperature below 0 °C or 32° F):



When outdoor temperature drops to around or below 0 °C (32° F), check the cooling system and if necessary add the recommended antifreeze.

**Warning:** Do not inject fluids (Ether) to make the engine easier to start in cold weather.

##### 3.6.2. Proceed as Follows:

- 1 Perform operations A, B, C and D as instructed above.
- 2 Turn the Starter Key to 'Heat' position and keep it there for few seconds and then turn the key to start position.
- 3 If the engine fails to start repeat Step 2, wait a further 10 to 15 seconds and then turn the key to start position again.

##### Note:

- 1 If the engine fails to start after two or three attempts and smoke can be seen coming out of the exhaust, repeat the starting procedure with less time glow plug heater.
- 2 Do not keep the key turned to start position for more than 15 seconds at a time.



- 3 Wait at least one minute between every two attempts of starting the tractor.

If the engine does not start regularly and easily, do not continue as for you may run down the battery. Bleed any air that may have accumulated in the fuel system and, if the problem persists check that:

- 1 Fuel filters are not blocked
- 2 The battery and Heater Plugs are working efficiently.

**Note-** Before starting a cold engine in cold weather first cover the radiator with a radiator cover. Remove the cover as soon as a normal working temperature is achieved.

**3.6.3. Running in:-** It is essential to take the following precautions during the running in period:

- 1 During this period, do not subject the tractor to loads greater than those it will have to deal with during the rest of its working life.
- 2 Engage low gears when towing heavy loads.
- 3 When running in, check regularly that all screws, nuts and bolts are tight.
- 4 To ensure prolonged clutch life, run in the clutch discs correctly.

**3.6.4. Turning off the engine:**

- 1 Turn the engine accelerator to idle position
- 2 Turn the starting Key to 'Off' position
- 3 Stop the engine by pulling the fuel cut-off lever till engine stops.

## **3.7 FUEL SYSTEM**

### **3.7.1 FUEL SAVING TIPS**

Maintain your tractor. Badly maintained tractor wastes 25% of precious fuel.

Always top up tank at the end of day to avoid water contamination in fuel tank due to moisture.

Change fuel filter regularly as per maintenance schedule. Use genuine fuel filter available at authorized dealer. Also clean feed pump, filter and drain out water from filters as per schedule.

Prevent fuel leakage.

For better performance of tractor follow running in process mentioned in this manual

Do not ride the clutch.

Run tractor with appropriate speed and gear combination.

Do lengthwise field operation.

Always keep the specified tyre pressure for road and field operation.

Switch off the engine when the tractor is not in use.

Avoid wheel slippage

Attached tractor trolley at appropriate height.

Do not over load tractor beyond capacity.

## 3.8 HYDRAULIC

### 3.8.1 HYDRAULIC SYSTEM

In this tractor live hydraulic system is provided. In which hydraulic pump is driven by engine and mounted at cover of engine. As the engine run, the hydraulic pump also starts working. Transmission lubrication oil is used as hydraulic oil.

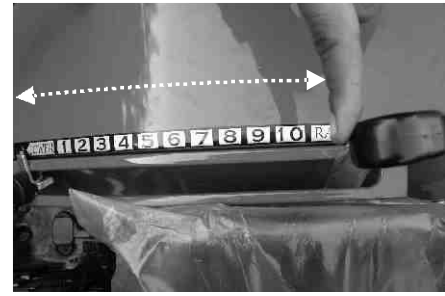

### 3.8.2 TRANSPORT LOCK

It acts as safely device during transportation of implements. It is located on front side of Hydraulic Rear Cover below driver seat.

**Use :** For safety lock fully tighten the response valve by rotating in clockwise direction

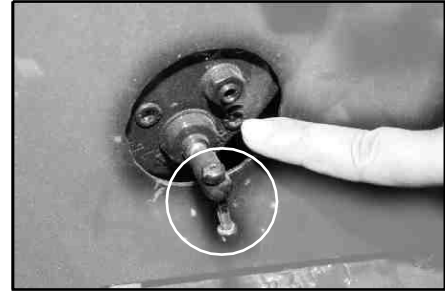

Response Valve should always be closed during implements transportation.

### 3.8.3 THREE POINT LINKAGE

Three-point linkage is used to mount the implement, which is fully mounted, or semi-mounted and used for different field operation. Three-point linkage is controlled by hydraulic lever. In this two lower link are available, of which one side of the lower link is attached with differential housing and other is used to hitch the lower pin of the implement. Lift rods are mounted on lift arm that is operated through rockshaft. Loose side of Top link is used for attaching upper hitch pin of implement. Top link is adjustable for proper setting of implement and ease at the timing of joining.

#### 3.8.3.1 LIFT RODS (A & B)

If lift rod is fitted with lift arm and lower link, the length of lift rod (A&B) cannot be adjusted.

#### 3.8.3.2 TOP LINK (C)

For length adjustment of top link, fix the top link other end and turn the lever for increasing or decreasing the length. During field operation lock the tube to avoid unnecessary turning.

#### 3.8.3.3 LOWER LINKS (E)

Lower Links are provided for hitching the implement.

#### 3.8.3.4 ATTACHING IMPLEMENT TO 3 POINT LINKAGE

Position the tractor to align corresponding linkage with the hitch points of implements. Keep the implement on hard & leveled surface and attach as per given below instructions :

- First attach with Left lower link (E) and Right Lower Link (F)
- Then at Last attach with Top Link (C)

#### 3.8.3.5 DIRECTIONAL CONTROL VALVE (DCV)

The tractor is equipped with single acting directional control valve. The operator is with a lever located on LHS of driver seat. And the coupler (quick attach) is at rear side of tractor.

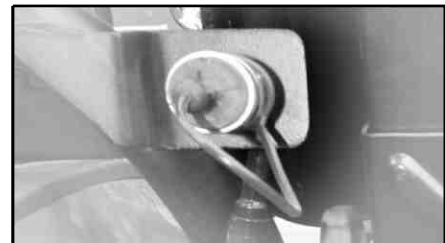

Use only single action cylinder implement.

## 3.9 WHEELS AND TYRES

Tyres Play vital role in transportation and agriculture operations. It is the most important factor in the efficient performance of tractor it should be used only as per company recommendation. Here we will discuss only pneumatic tyres.

On any tyre there is some marking which represents its size & capacity e.g. Tyre marking is 8x18, 4 ply rating i.e. 8 inch is the section width, 18 inch is the bead diameter. Ply rating doesn't show that the same No. of plies are inserted in tyre. It is only comparative measure of the load carrying capacity (L.C.C) of tyre. As more ply rating shows more L.C.C. at the same time as L.C.C. increase the shocks absorption capacity decreases.

In general, tractor is considered for two types of work:

- Work on soft soil where maximum adhesion is needed. In this case there will be use of lowest pressure compatible with the load carried.
- Work on hard ground and roads, towing etc. In this case there will be use of maximum pressure.

### 3.9.1 IN FIELD OPERATIONS

(Recommended Tyre Pressure : Front - 1.75 Kg/cm<sup>2</sup> & Rear .84 Kg/cm<sup>2</sup>)

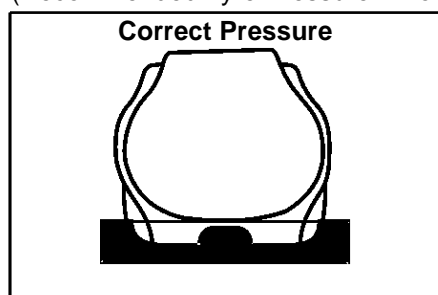

- Good adherence by dirt grousers.
- Good cleaning of the tread

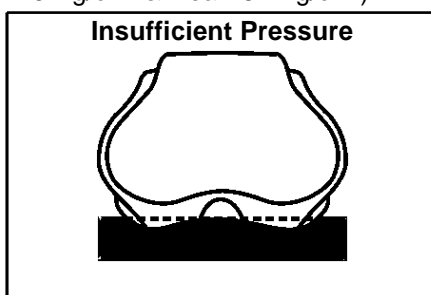

- Reduce adherence through lack of tyre grip.
- Deterioration of tyre casing by traction forces.

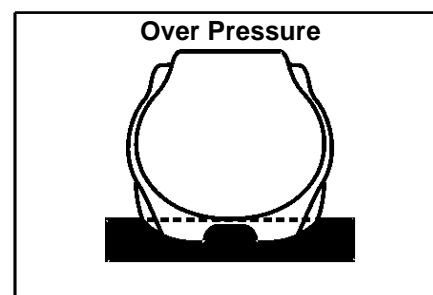

- Reduce group due to lack of cleaning
- Deterioration due to compacted ground.

### 3.9.2 ON ROAD OPERATIONS

(Recommended Tyre Pressure : Front - 2.15 kg/cm<sup>2</sup> & Rear 1.57 kg/cm<sup>2</sup> q Cm)

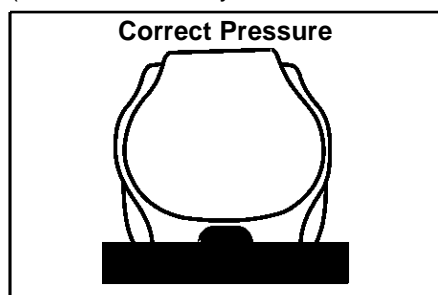

- Resistance to Wear

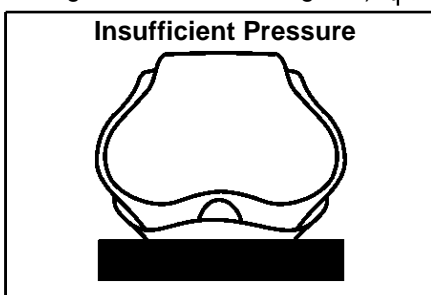

- Reduce adherence through lack of tyre grip.
- Deterioration of tyre casing by traction forces.

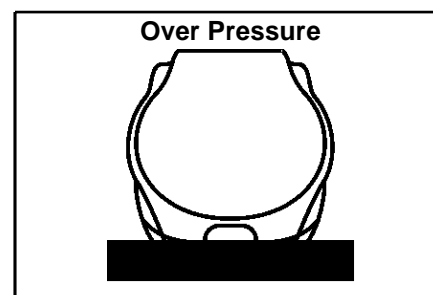

- Reduce group due to lack of cleaning
- Deterioration due to compacted ground.

### 3.9.3 RECOMMENDED LOAD CARRYING CAPACITY

TYRE	TYRE SIZE	Pressure (kPa)					
			80	100	120	140	160
REAR	8 - 18	4 Ply Rating	345	395	440	480	520
FRONT	5 - 12		115	135	150	160	175

**NOTE:** Tyre pressure should never maximum pressure as recommended the tyre could burst. Change / repair any worn or faulty tyre (cuts, cracks etc.) immediately to prevent the problem become more severe

### 3.9.4 BALLASTING OF TRACTOR

Proper ballasting is an important factor in tractor performance. For better performance of tractor, the weight of tractor can be decreased as per requirement. Maximum productivity can be achieved only if tractor weight is appropriate for the job. Ballast is required for traction and stability. Following factors determine amount of ballast.

- Soil surface loose or firm
- Type of implement
- Travel speed and tractor power output partial or full load.

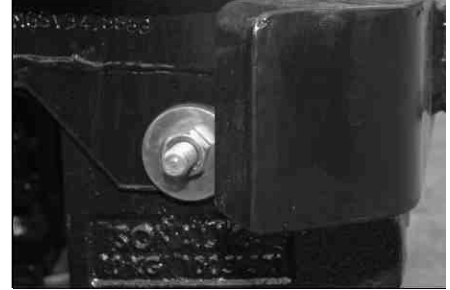

### 3.9.5 FRONT WHEEL TOE IN

After setting the track width is necessary to adjust toe in of the front axle.

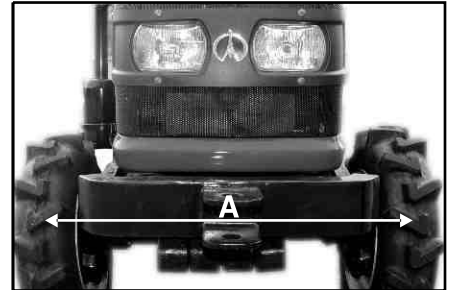

### 3.9.6 CHECKING AND ADJUSTMENT OF TOE-IN

Firstly park the tractor on level surface. Turn the steering wheel so that front wheels are in the straight-ahead position. Stop the engine. Measure distance (A) between tyres at hub level in front of axle. Record measurement and mark the points on tyres. Move tractor back about 1 meter so that mark on the tyre is at hub level behind the axle.

Again measure distance between tyres at same point on tyre. Record the measurement. Determine the difference between front and rear measurement. If the front measurement is smaller toe is 'In'. If the rear is smaller, toe is 'Out'. Distance (A) at front or tyres should be 3-6 mm less than distance measured at rear of tyres.

Adjust toe-in If necessary. For adjusting toe-in loosen the lock nuts (B) on both sides. Turn the tie rod and adjust toe in to 3-6 mm.

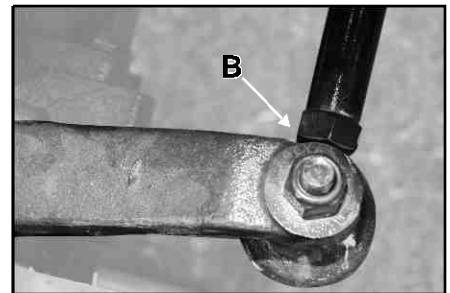

### 3.9.7 REAR WHEEL TRACK WIDTH ADJUSTMENT

Track width of the rear axle can be adjusted by repositioning or exchanging the rims or by reversing the wheel discs. Track width can also be adjusted by exchanging the complete wheel to the opposite side of tractor. This manual permits the change from disc dished in to disc dished out operations without disassembling the wheel. When changing rear wheels from one side to the other, the arrow on sidewall of tyre points in the direction of forward rotation. A study of following diagram, from attempting to change track width setting will save unnecessary labour.

DIAGRAM	TRACK WITH	
	8 X 18	
(REAR) B	720	(725 - 860) MM
(FRONT) A	840	(520 - 103) MM

### Trouble Shooting (Tyre Complaints)

Problems	Factor Effecting	Corrective action
<b>Alternate wear tread</b>	<ul style="list-style-type: none"> <li>Inappropriate pressure in tyres.</li> <li>Continuous use of tyres for excessive load on road with two-tyre trailer.</li> <li>Incorrect matching of tractor with trailer.</li> </ul>	<ul style="list-style-type: none"> <li>Maintain appropriate pressure in tyres.</li> <li>There should be check up of tyres pressure from time to time.</li> <li>There should be correct matching of tractor with</li> </ul>
<b>Sidewall or Shoulder damage</b>	<ul style="list-style-type: none"> <li>Damage by sharp edges things like stones, pieces of glass etc.</li> <li>Tyres damage with linkages while turning.</li> </ul>	<ul style="list-style-type: none"> <li>Maintain appropriate pressure in tyres.</li> <li>Never turn the tractor instantly.</li> </ul>
<b>Scoop or wear from high center</b>	<ul style="list-style-type: none"> <li>Excessive pressure led to early wear of tyres.</li> <li>Use of tractor in transportation for longer period.</li> </ul>	<ul style="list-style-type: none"> <li>Proper inflation and ballasting of tyres during</li> </ul>
<b>Puncture of tyre again and again:</b>	<ul style="list-style-type: none"> <li>Places where Crops like Sunflower, Sugarcane &amp; Cotton etc that are with sharp edges stem and deep roots have more probability to cause damage to tyre.</li> </ul>	To over come this problem, wheel track should be
<b>Damage to tread/crown of tyre</b>	<ul style="list-style-type: none"> <li>Merging of sharp edges things in tread/crown area.</li> <li>Contact with stones, pieces of glass, steel or crops with sharp edges stem and deep roots etc.</li> </ul>	<ul style="list-style-type: none"> <li>Don't run the tractor with high speed on sharp edges areas.</li> </ul>
<b>Damage of tyre due to less</b>	<ul style="list-style-type: none"> <li>Less inflation pressure of tyre.</li> <li>Overload</li> </ul>	<ul style="list-style-type: none"> <li>According to the load, pressure should be there in tyres.</li> </ul>

### 3.9.8 GENERAL SUGGESTIONS

- Always maintain proper inflation of tyres.
- Tyre should be ballast to over come the problem of slippage.
- Tractor should be park in shed area in order to avoid the direct contact of sunrays with tyres.
- If tractor is not in use for longer period then tyre should be jacked
- Avoid the contact of oil & grease with tyres.

### 3.9.9 CHECK WHEEL NUT BOLT

Check wheel nut of the front and rear wheel. Torque it as per specification.

- Wheel body on hub
- Rear wheel : 130-130 NM
- Front wheel : 72 NM



## 4. GENERAL MAINTENANCE

### 4.1 ENGINE

#### 4.1.1 ENGINE LUBRICATION SYSTEM

We recommend the grade SAE15W 40 as mentioned in service schedule.

#### 4.1.2 CHECK ENGINE OIL LEVEL

Before checking the oil level be ensure that tractor is parked on leveled ground. Stop the engine and wait for some time, as all oil should return to oil sump.

Check the oil level by unscrewing dipstick (A) Top up the oil level if the level is below the minimum level mark. Do not over fill than maximum level mark.

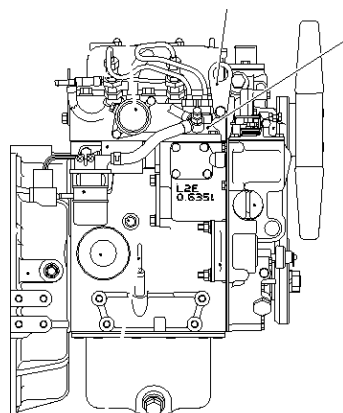
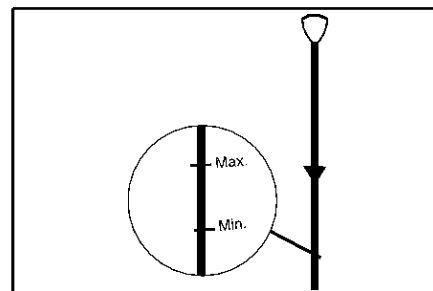

#### 4.1.3 CHANGING OF OIL FILTER & ENGINE OIL

##### CHANGING OIL FILTER (Spin-on type):

1. Stop your tractor to the side of road on leveled surface and drain the engine oil in an oil pan after removing the drain plug.
2. Remove the oil filter by rotating it in anti-clockwise direction by hand or with the filter wrench.
3. Take new oil filter and check it for proper seating of gasket.
4. Apply clean engine oil to gasket on the new oil filter.
5. Install oil filter. When the filter gasket contacts the mounting surface of filter, tighten the new oil filter.

##### REFILLING ENGINE OIL :

1. Re-install the Drain plug and remove the oil filler cap.
2. Fill the engine oil with the specified engine oil (SAE 15W 40) to the specified level to sump capacity. (3.1 Ltr.)
3. Insert into the oil level gauge guide, then pull out the gauge again.
4. Ensure that oil level should be between the MAX. & MIN. marks on the oil level gauge. If less then pour the oil to bring it to specified level.
5. Install the oil filler cap after a refill.
6. Check the oil pan and other parts for oil leakage.
7. Start the engine, allow it to run idle and don't race it immediately.

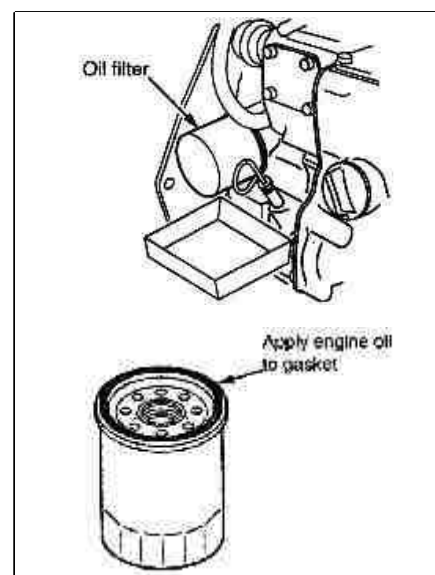

#### 4.1.4 CHANGING OF FUEL FILTER (Spin-on type)

1. Shut down fuel cock.
2. Remove the filter by rotating it in anti-clockwise direction by hand or special wrench.
3. Take new filter and check it for proper seating of gasket.
4. Apply clean engine oil to gasket on the new fuel filter.
5. Install fuel filter, when the filter gasket contacts the mounting surface of filter, tighten the filter and ensure that there is no leakage.

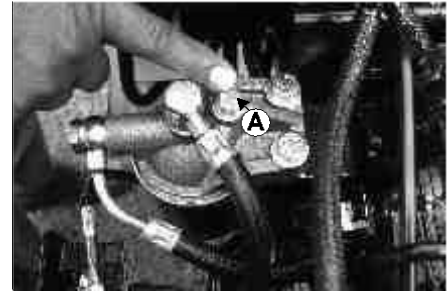

#### 4.1.5 AIR BLEEDING FROM FUEL INJECTION SYSTEM/ FUEL FILTER REPLACEMENT

After changing the fuel filter the system must be air - bleed in this manner:

1. Switch ON the ignition key to start the electric pump till completion of air bleeding process.
2. Loosen the vent plug (A) at the top of fuel filter body.
3. Tighten the vent plug (A) until the bubble free fuel flows from the air vent plug hole.
4. Loosen the return valve (B) of FIP and allow the air to flow out from the system.
5. Tighten the vent plug (B) until the bubble free fuel flows from the return valve.
6. Loosen the injector pipes (C,D,E) and crank the engine till the bubble free fuel flow is ensured.
7. Tighten all the injectors.

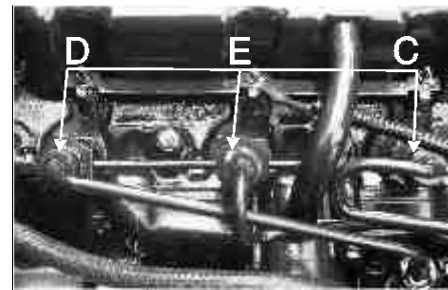
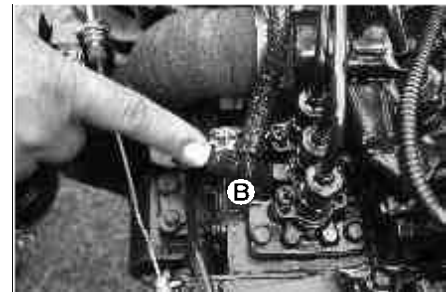

## 4.2 AIR CLEANER

### 4.2.1 OIL BATH TYPE AIR CLEANER

Tractor is fitted with two stage (pre cleaner (A) and oil bath type air cleaner (B) air filtration system.

If the dust enter in the engine with the air it will cause wear of various moving parts of engine, therefore should be cleaned and serviced depending upon the operating conditions. Under extremely dusty conditions the time limit recommend for cleaning should be decreased. Proper maintenance of the air cleaner extends the life of the engine. Here the air impinges upon the surface fo the oil and particles of foreign matter are carried into the oil by their own momentum and trapped.



### 4.2.2 CLEANING OF PRE-CLEANER (DRY)

The function of pre-cleaner is to remove the dust/waste particles from air before entering the air cleaner.

1. Unscrew the cover nut (C)
2. Remove the cover(D)
3. Take out the Glass bowl(E), Clean it and reassemble in reverse procedure.

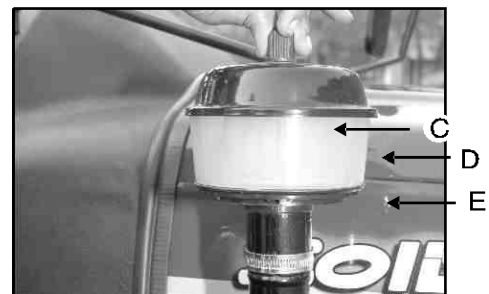

#### 4.2.3 AIR CLEANER BOWL & ELEMENT CLEANING (WET)

1. Remove the oil pan after opening three clamps.
2. Take out the oil filter element and immerse it in cleaning solvent and rinse wash. Then dry the element with compressed air.
3. Drain the oil from the oil pan. Scrap out all the accumulated sludge and rinse in cleaning fluid.
4. Refill the oil pan to the marked level with 200ml oil.
5. Reverse the removal procedure to reinstall it.



#### 4.2.4 AFTER EVERY 50 HRS

Replace air cleaner oil and clean wire mesh element. Remove the wire mesh filter element clean it with diesel or kerosene. Dry well before assemble it.

Ensure proper seating or Rubber Rings. Replace if damage.



Note : In case of dusty atmosphere oil change period is 16 hrs.

## 4.3 RADIATOR

### 4.3.1 COOLANT LEVEL IN RADIATOR (HOT)

Slowly unscrew the radiator cap up to the safety catch (about 1/3 turn). Wait to allow the steam to escape. Continue unscrewing the cap, press it down firmly to release the safety catch. The level of coolant should just touch the tab located in the filling spout. If the level has dropped, check the entire cooling system for external leakage (radiator, hoses etc.) If there is no external leakage, top up the coolant.

Fill the reserve tank with coolant upto the FULL line mark for coolant TOP UP.

**Coolant is mixture of water and recommended anti scaling / anti rusting / anti freeze agent in recommended ratio, as described below:**

Recommended Anti Scaling / Rusty (VEEDOL ZEROR) 300ML  
Use of antifreeze (%) in case of operation in sub Zero Temperature

Ambient Temperature Range °C (°F)	Upto -15 (5)	- 15 to -23 (-11)	- 23 (-11) to -36 (-32)	-36 (-32) to -33(-35)
Antifreeze (%)	30	30	50	55

### 4.3.2 RADIATOR DRAINING & FLUSHING (When Cold)

1. Remove the radiator cap and drain plug.
2. Let the coolant drain out. Close drain cocks and plugs. Flush the cooling system with water / Cleaning Solution for 15 minutes at engine oil, then drain the cleaning solution.
3. Refit the drain plug and refill the coolant (Mixture of water, anti scaling agent, antifreeze) as mentioned in 4.3.1.
4. Run the engine with radiator cap open and depress accelerator 2-3 times and Top up coolant if required.
5. Refit the radiator cap and ensure tightness all the connections for any leakage.

### 4.3.3 RADIATOR FINS CLEANING

1. Check Radiator Fins for holes or cracks for chocking.
2. To clean the radiator from engine side to outside blow com

### 4.3.4 RADIATOR CAP

Cooling system is closed pressurized system so don't operate the tractor without radiator cap or cap with damaged rubber seals/defective release valve to avoid water loss and engine overheating.  
Use genuine radiator cap only.

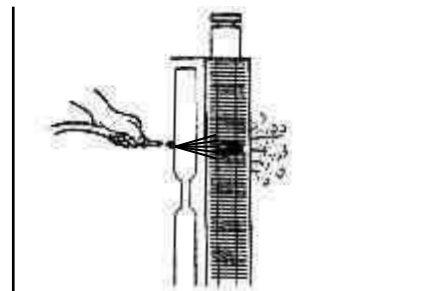

## 4.4 HYDRAULIC

### 4.4.1 TRANSMISSION/HYDRAULIC OIL LEVEL

To check the Transmission/Hydraulic oil level unscrew the dipstick (which is mounted on R.H.S. of main gear shifter lever). Check the oil level and TOP up if needed.

Note: Keep the oil level up to maximum oil level mark.



### 4.4.2 CHANGE TRANSMISSION OIL

Before draining the oil, heat up by running engine, transmission and hydraulic system. Park the tractor on level ground, turn off the engine and then drain the oil by opening the drain plug provided at bottom of gear box and differential housing. Fill the new oil. Check the level by dipstick.

Tighten the drain plug.

Hydraulic + Transmission Oil capacity 15.7 Ltr. (approx.)

Grade: EP-80

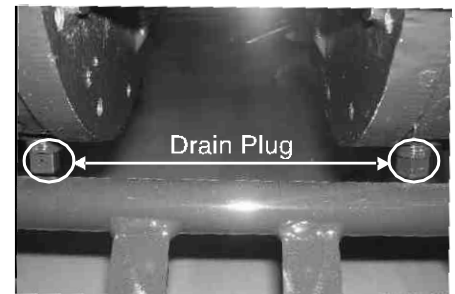

### 4.4.3 CHANGE STEERING GEAR BOX OIL

Drain out the oil by removing the side plate of steering gear box assembly. Keep oil level up to level plug.

Steering Oil capacity 500 ml (approx.)

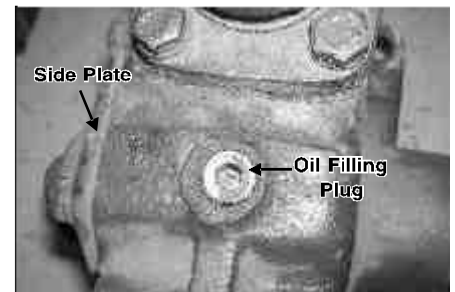

### 4.4.4 FRONT AXLE OIL LEVEL

Oil level check plug is provided on R.H.S. of front axle. Open the plug and check the oil level. The lower point of plug should be immersed in oil.

Capacity :2.0 Ltr.

Grade : EP 80



## 5. OTHERS

### 5.1 (A) TECHNICAL PARAMETERS : SOLIS - 20

<b>DESCRIPTION OF ENGINE</b>	
Make	MHI-VST Diesel Engines Pvt. Ltd.
Type	4 stroke, Naturally Aspirated, Liquid Cooled, IDI, Diesel Engine
Model and Identification	MVL3E
Intake system	Natural Aspiration
Working principle (Four/Two stroke)	Four Stroke
Bore/Stroke(mm)	76/70 mm
Number and layout of cylinders and firing order	03 no. of cylinders; Inline Layout; Firing order 1-3-2
Cylinder capacity	952 cc
Compression ratio (Specify the tolerance)	23:1 ± 0.5
Arrangement of valves	Overhead, inline
Injection timing	170 ± 10 BTDC
Injectors Opening Pressure	13.7 (+1.3) MPa
Type of Governor	Mechanical
Make(s) Country or origin	MITSUBISHI HEAVY INDUSTRIES LTD. (JAPAN)
Engine Rated speed	2700rpm
Fly up	2970 ± 50 rpm
Low Idling	1000 ± 30 rpm
HP at rated RPM	18.22
Max Torque (Nm)	52.3Nm@2600 RPM
<b>VALVE CLEARANCE (Cold / Hot)</b>	
Intake / Exhaust (mm)	0.25
<b>LUBRICATION SYSTEM</b>	
Description of systems	Force Feed-Cum-Splash
Position of lubricant reservoir	Oil sump at bottom of Engine block
Type of lubrication Pump	Gear pump
Capacity of pump at rated (Engine/pump) rpm	14 Lpm at rated speed
pressure release seating Kpa / (Kgf / cm <sup>2</sup> )	294 ± 29.4 kPa (3.0 ± 0.3 kgf/cm <sup>2</sup> )
Oil sump capacity (l)	3.1 Liters
Total Lub. Oil capacity (l)	3.6 Liters
<b>COOLING SYSTEM</b>	
liquid / air cooling	Liquid Cooling
Characteristics of liquid-cooling system	Forced water circulation Opening Start - 76.5°C
Thermostat setting	Full Open - 90°C
<b>EXHAUST SYSTEM</b>	
Type of Silencer	Vertically downward, cylindrical

<b>TRANSMISSION SYSTEM</b>	
<b>Clutch</b>	
Type	Dry, friction plate
<b>Gearbox</b>	
Type	Sliding Mesh
<b>OVERALL DIMENSIONS (mm)</b>	
Width	950
Height	1950
Length	2310
Ground clearance	250
Wheel base	1420
<b>Minimum radius of turning circle</b>	
With Brake (m)	2.4
Without Brake (m)	2.9
<b>Trade Width</b>	
Front	820 (Adjustable 820-1030)
Rear	725 (Adjustable 725-860)
<b>BRAKES</b>	
Type	Mechanical, Expandable shoe & drum type
<b>POWER TAKE OFF</b>	
TYPE	Type-1
PTO RPM @ 2700 RPM	C1-630, C2-930, C3-1605
<b>STEERING SYSTEM</b>	
Type	Mechanical (Manual)
<b>FUEL TANK</b>	
Capacity	30Ltr.

### (B) TECHNICAL PARAMETERS : SOLIS - 20

<b>PTO PERFORMANCE</b>	
Max Power (kW)	14.98
Rated Power (kW) 13.4@2700	13.4 kw
Maximum equivalent crank shaft Torque (nm)	45
Back up Torque (%)	7% min.
SFC at Max Power (g/k Wh)	323
<b>DRAWBAR PERFORMANCE</b>	
Maximum Drawbar Power without ballasted (kw)	8.24
Maximum Drawbar Pull with Standard Ballasted Tractor (kN)	4.97

<b>POWER LIFT AND HYDRAULIC PUMP PERFORMANCE :</b>	
<b>Maximum lifting capacity throughout the range of lift, (kN) :</b>	
At hitch points	4
With the standard frame	3
Max. Hydraulic power, (kw)	3 ± 1
<b>Brief Specification of Implements used during field test</b>	
Disc plough	1 Bottom
Rotavator	28 Blade (J type) 3.5 feet Rotavator
Trailer	For Two Wheel, gross mass 3.0 tone.
Mold Board Plough	1 Bottom

#### Tractor Weight with ballasting and un-ballasting Condition

Particulars	Mass of the tractor without operator but with all liquid reservoirs full, (Kg)		
	Front	Rear	Total
Without ballast	370	440	810
With Ballast as used during drawbar performance test	360	420	780
With Ballast as used during field test (dry-land operation)	360	420	780
With Ballast as used during wet-land operation ( <b>cage Wheel Fitted</b> )	NA	NA	NA
With Ballast as used haulage test	360	420	780

<b>Accessories supplied with the tractor</b>	<b>Quantity</b>
<b>Accessories</b>	
Top link	1
Toe hook	1
Front ballast weight	4 (Front Weight) Standard Ballast
Tool Kit	1
Service Kit	Engine Oil Filters, Fuel Filters & Fan Belt
Operator Manual	1

<b>Nominal tractor Speed</b>			
Movement	Gear	Nominal speed at rated RPM with-8.0 - 18 rear tyres having radius index 414 mm	
		LOW	HIGH
Forward	1st	1.25	5.50
Forward	2nd	1.88	8.28
Forward	3rd	3.17	13.93
Reverse		2.60	7.03
No. of Speed	8 (6+2)		
<b>Tyre</b>		5.0 - 12	
Front Tyre Size		8.0 - 18	
Rear Tyre Size			



## 5.2 RECOMMENDED GRADE OF LUBRICANTS & GREASES

TRACTOR MODEL	SOLIS-20
ENGINE MODEL	MVL3E
ENGINE OIL	
QUANTITY	3.6 Liters
GRADE	15W 40
AIR CLEANER OIL	
QUANTITY	0.2 Liters
GRADE	SAE 20 W 40
TRANSMISSION OIL	
QUANTITY	17 Liters
GRADE	EP 80
HYDRAULIC OIL	In common with Transmission oil
GREASE	Multipurpose grease

### 5.3 SERVICE SCHEDULE

Observe the following service schedule. This service schedule is applied to tractors which are operated under normal conditions. When your tractor is frequently operated in muddy places, greasing must be carried out more frequently and when the tractor is often operated in dusty places, clean the air cleaner element and fuel filter more frequently. Extra servicing must be carried out according to particular situation.

Parameters	Specifications	50 hrs/ 1st Service	250 hrs/ 2nd Service	500 hrs/ 3rd Service	750 hrs/ 4th Service	1000 hrs/ 5th Service
Air cleaner bowl oil	SAE20W40	CR	C	R	C	R
Engine Oil	15 W40 (3.6 LTR)	R	R	R	R	R
Engine oil filter		R	R	R	R	R
Fuel filter element		R	R	R	R	R
Fan belt tension		CA	CA	CA	CA	CA
Radiator coolant		C	C	C	C	C
Battery leads		CT	CT	CT	CT	CT
Brake pedal free play		CA	CA	CA	CA	CA
Clutch pedal free play		CA	CA	CA	CA	CA
Transmission oil	EP 80 (17 LTR)	R	R	R	C	R
Hydraulic oil Strainer		C	C	C	C	C
Front hub end play		CA	CA	CA	CA	CA
Front axle differential oil	EP 80 (2.0 LTR)	R	C	R	C	R
Tappet clearance		CA	CA	CA	CA	CA
Dash board equipment operations		C	C	C	C	C
Retighten all fasteners		CT	CT	CT	CT	CT
Steering linkage		CT	CT	CT	CT	CT
Engine mounting bolt	72 NM	CT	CT	CT	CT	CT
Cylinder Head bolts	M12-11-12 Kg/m, M10-7-8 Kg/m	CT	CT	CT	CT	CT
Radiator Mounting bolts	M8-2.5-3 Kg/m	CT	CT	CT	CT	CT
Drag arm mounting bolts nuts	M12-8.5-9.5 Kg/m	CT	CT	CT	CT	CT
Gear box mounting bolts	35-40 Nm	CT	CT	CT	CT	CT
Front wheel bolts	72 Nm	CT	CT	CT	CT	CT
Rear wheel bolts	130-190 Nm	CT	CT	CT	CT	CT
Engine clutch housing bolts	35-40 Nm	CT	CT	CT	CT	CT

**R**-Replace, **CT**-Check & Tighten, **C**-Check, **CR**-Clean & Replace, **CA**-Check & Adjust  
Beyond 1000 Hrs Repeat the cycle every 250 hrs.

## 5.4 GREASING POINTS ON TRACTOR

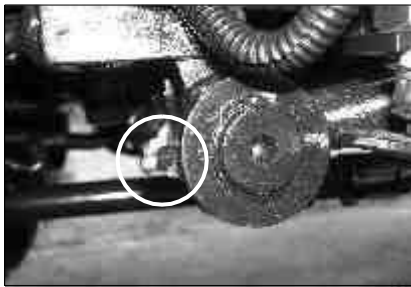
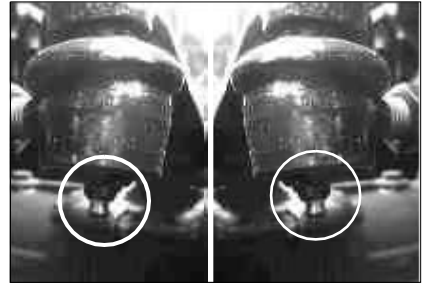
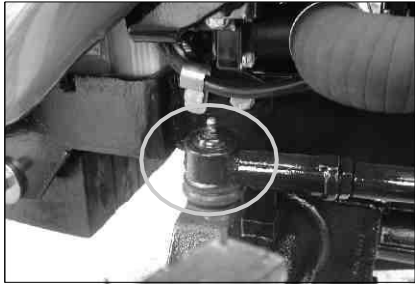

## 5.5 WIRING DIAGRAM

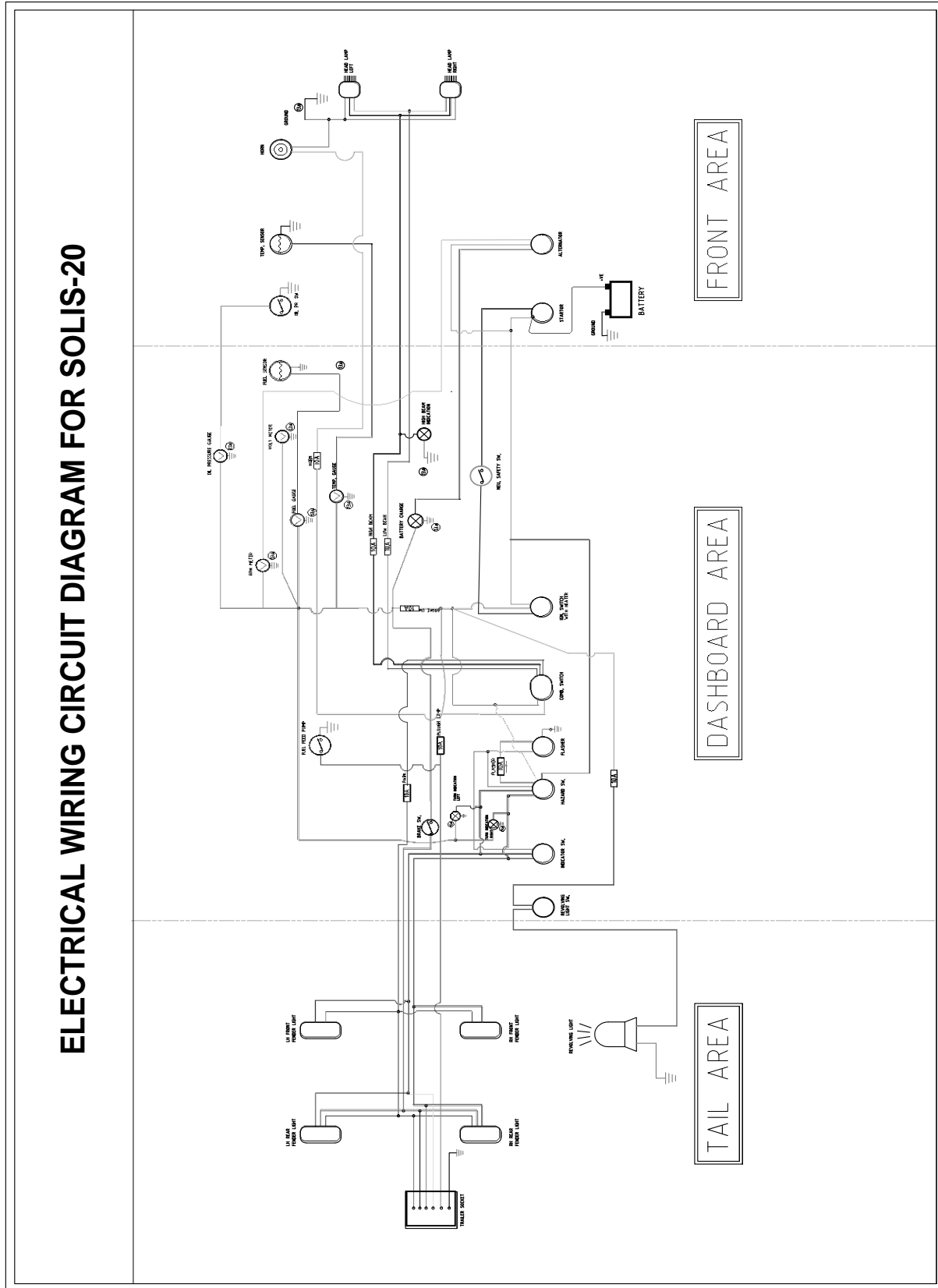

## 5.6 WARRANTY

ITL Tractor Division (hereinafter called "Company") warrants to the retail purchaser of the Products manufactured by them that the Company's dealer will repair or replace any part thereof subject to limitations specified herein below found to be defective in materials or workmanship in their opinion, **within 18 months or 1500 hours of operation**, whichever occurs earlier, from the date when the products are delivered new to the original retail customer (the Purchaser) For the fuel injection pump and battery warranty will be up to **12 months or 1000 hrs of operation**, whichever occurs earlier.

This warranty is limited to the delivery to the purchaser, free at the Authorized Dealer's workshop or Company's works, of the part or part whether new or repaired, in exchange for those acknowledged by the Company to be defective.

The Company's responsibility is limited to the terms of this Warranty and it shall not be answerable for personal injuries or consequential or resulting liability, damage or loss arising from any defects. This warranty shall not apply to defects/damages caused by normal wear and tear, accidents, misuse or neglect, or to defects in the Products which have been altered outside the Company's works or which have been let out on hire or the identification marks on which have been altered or removed.

The Company's Liability under this Warranty is dependent upon the strict observance by the Purchaser, of the following provisions :-

- (a) The Purchaser at the time of delivery shall sign, complete and return the Authorized Warranty and Dealer's Report form.
  - (b) The Authorized Dealer only will perform repairs of replacements, following delivery of the product by the purchaser to the Dealer's place of business.
  - © This Warranty shall not apply if the Product or any part thereof is repaired or altered otherwise in accordance with our standard repair procedure or by any person other than our Authorized Dealer or their branch dealer or their service centers in any way.
  - (d) The Purchaser shall at all times in the operation of any the Company's products use only those brands of lubricating oil, lubricants or fuel, officially approved in writing by the Company.
  - (e) The judgment of the Company or its Authorized Dealer in all cases of claims shall be final and conclusive and the Purchaser agrees to accept its decision on all questions as to defects and to the exchange of part or parts. After the expiration of six days from the dispatch of notification of the Company or the Authorized Dealer's decision, the part or parts submitted may be scrapped or returned carriage forward by the company or its Authorized Dealer.
  - (f) Claims arising from this warranty will be recognized only if they are in writing to our Authorized Dealer concerned or to us without delay, after the defect has been ascertained.
  - (g) We reserve the right to make changes in design or introduce any improvement or add any part on Product at any time without incurring any obligation to install the same on products previously sold.
  - (h) The warranty shall become void if the product is not serviced at any of the company's authorized dealers during the warranty period and that the all-regular recommended services have been carried out.
5. Use of non-genuine spare parts will invalidate this Warranty.
  6. The above Warranty is in lieu of all other Warranties express or implied, and no person, agent or representative of the Company is authorized to give any other warranties on the Company's behalf or to assume for it any other liability in connection, with the products.
  7. All the proceedings relating to any dispute arising between the Company and the Purchaser on the liability of the Company under this Warranty shall be taken in Civil Court having jurisdiction in Hoshiarpur only.

## 6. DO'S & DONT'S

### DO'S

#### ENGINE

##### a. General

1. Do release the starter key once the engine has started.
2. Do check the proper functioning of oil pressure gauge and battery charging indicator once the engine has started.
3. Do get the tightness of cylinder head and manifold nuts checked regularly.

##### b. Air inlet System

1. Do inspect the element pre / cleaner / oil bath and clean if necessary.

##### c. Fuel System

1. Do drain sediments form the fuel tank periodically
2. Do clean fuel tank thoroughly once in every 500 hrs.
3. Do change filter regularly as recommended as per recommended service schedule.
4. (If applicable)
5. Do fill in diesel in the tank at the end of the day's work so as to avoid condensation.
6. Do ensure that pull to stop cable/knowb is not in pulled condition.

##### d. Water cooling System

1. Do ensure that radiator is always filled with clean (soft) water & radiator cap in tight
2. Do clean the radiator front grill to ensure free flow of air when the engine is operating.
3. Do ensure proper tension of fan belt. Deflection should not be more than (10 mm) when pressure is applied between the fan pulley and the crankshaft pulley.

##### e. Lubrication System

1. Do replace engine oil after first 50hrs. of operation. Thereafter, engine oil should be refilled every 250 working hrs.
2. Do check oil level daily with tractor parked on a level ground.
3. Do replace lub. oil filter element every 250 working hrs. After 1st replacement at 50 hrs.

#### CLUTCH

1. Do ensure that clutch free pedal play is between 25 to 30 mm.
2. Do ensure that the clutch pedal is released slowly while moving the tractor.

### DON'T'S

#### ENGINE

##### a. General

1. Do not keep on continuously cranking the engine with starter key. It will shorten the life of battery.
2. Do not race the engine in neutral condition.

##### b. Air inlet System

1. Do not run the tractor if the air cleaner assembly is defective as this will lead to impure air being taken in and consequently excessive wear of liners and piston rings.

##### c. Fuel System

1. Do not keep the fuel tank without a proper sealing cap.
2. Do not use contaminated fuel as it may affect the operation of fuel injection pump and the injectors.
3. Do not allow leakage through fuel pipe joints.

##### d. Water Cooling System

1. Do not run the tractor with the radiator cap removed/non-acting radiator cap.
2. Do not run the tractor when the radiator hoses are leaking as it will lead to overt heating of the engine.
3. Do not remove thermostat as it will affect engine performance.
4. Do not run the belt tight as it will lead to premature failure of water pump and alternator bearing.
5. Do not run the belt loose as it will lead to inefficient cooling and improper charging of the battery.

##### e. Lubrication System

1. Do not use wrong grade of lubrication oil.
2. Do not mix different brands of engine oil.

##### f. Exhaust System

1. Do ensure that the exhaust passage is not blocked.

#### CLUTCH

1. Do not rest the foot on the clutch pedal.
2. Do not work the tractor by slipping and re-engaging the clutch.
3. Do not coast down steep slopes with tractor in neutral/with clutch pedal depressed.

## DO'S

### TRANSMISSION

1. Do change the transmission oil after 1000 hrs. of operation.
2. Do check the condition of rubber protection bellows on the gear levers periodically as they prevent infiltration of water and dust into gear box.

### HYDRAULIC SYSTEM & LINKAGE

1. Do ensure that hydraulic control lever is in down position while draining the transmission oil.
2. Do ensure that the hydraulic strainer is cleaned at every schedule.
3. Do adjust the top link for proper length.
4. Do ensure that the lift cover bolts are always tight.
5. Do keep the lower links in lifted position when the tractor is moving without an implement mounted on it.
6. Do keep the ball joints on top and lower links clean and dry. Do not lubricate them.
7. Do ensure that implements are raised and lowered using the control lever.

### BRAKING SYSTEM

1. Do keep the brake pedals locked with interlocking latch when the tractor is not being used in field.
2. Do use parking brakes when the vehicle is stationary
3. Do check loose connections in linkage mechanism
4. Do grease brake pedal bush, brake bracket connections.

### FRONT AXLE & STEERING MECHANISM

1. Do lubricate the Bushes and steering drag links periodically.
2. Do get the toe-in adjusted by an authorised service centre periodically. It should be maintained between (3-6 mm)
3. Do check the tightness of front and rear wheels recommended torque (Front wheel is 72 Nm, Rear wheel 130-190 Nm)
4. Do flush oil once a year or 1000 hrs which ever is earlier.

### TYRES

1. Do operate the tractor with correct tyre pressure. This will lead to better traction, longer tyre life and better fuel consumption.

## DONT'S

### TRANSMISSION

1. Do not use top gears with low engine rpm.

### HYDRAULIC SYSTEM & LINKAGE

1. Do not move the operational control range to fast response, while the tractor is on a hard surface like concrete, as the implement will crash down and get damaged.
2. Do not attempt to pull or tow anything from the top link connection. It is dangerous.
3. Do not use bolts in place of linch pins.
4. Do not reverse the tractor with PTO driven implement attached and PTO lever in ground PTO position implement may get damaged in reverse.

### BRAKING SYSTEM

1. Do not attempt to turn sharply using independent brakes when travelling at high speed. This may cause the tractor to overturn.
2. Do not rest foot on the brake pedal.

### FRONT AXLE & STEERING MECHANISM

1. Do not use wrong grade of oil for lubrication of steering gear box.

### TYRES

1. Do not allow oil, grease and some crop spray containing considerable amounts of acid and alkalis to contaminate the tyre. These can cause considerable damage to the tyre if they penetrate into plies through small holes or splits.
2. Do not operate the tractor with excessive tyre pressure.

## DO'S

### ELECTRICALS

1. Do ensure that the battery terminals are kept clean.
2. Do ensure terminal base is Lubricated with petroleum jelly.
3. Do earth the tractor by wrapping a chain around the front axle, dropping one end of the chain on the ground while working with stationary PTO driven implement. This saves the electric equipment from damage due to static electricity.
4. Do clean the switches periodically using a jet of air.

### SAVE DIESEL

Let's Join hands

- Do switch off the engine when tractor is not in operation. Avoid unnecessary idling.
- Do operate at Optimum speed and correct gear.
- Do maintain the recommended tyre pressure for fuel efficient operation and long life of tyres. Check daily.
- Do use matching trailer for transportation. Ensure proper hitching. Never overload the trailer.
- Do maintain your tractor in good working condition.
- Do replace genuine parts from SONALIKA Authorised Dealers.

### For Better performance

- Ensure that safety shields are in place and in good condition.
- Read all operating instructions before commencing to operate Tractor.
- Keep the air cleaner clean.
- Fit new sealing rings when the filter elements are changed.
- Watch the oil pressure gauge or warning light and investigate any abnormality immediately.
- Ensure that the transmission is in neutral before starting the engine.
- Keep all fuel in cleans storage and uses a filter when filling the tank.
- Attend to minor adjustments and repairs as soon as the necessity is apparent.
- Allow the engine to cool before removing the radiator filler cap and adding water, remove the radiator cap slowly.
- Shift into low gear when driving down steep hills.
- Latch the brake pedals together when driving on a highway.

Ensure daily care of your tractor to avoid breakdowns.

## DONT'S

### ELECTRICALS

1. Do not change leads of the battery terminals as this will lead to failure of electrical components.
2. Do not leave the battery leads in the connected position if the tractor is not going to be used for a long period of time.
3. Do not overfill the battery with distilled water. The level should be just enough to submerge the battery plates.
4. Do not do any welding in the tractor without disconnecting Battery terminals.

### EVERY DROP COUNTS

To save oil

- Do not allow fuel or oil to leak. Ensure that the joints are adequately tight.
- Do not spill fuel or oil while filling or topping up. Use a funnel.
- Do not overfill engine oil as this can cause excessive oil consumption and oil leaks.
- Do not overfill engine oil as this can cause excessive oil consumption and oil leaks.
- Do not ride the clutch or brake pedal.
- Do not allow the rear wheel to slip. Use ballast, if necessary.
- Do not use worn-out tyres.
- Do not use inferior quality lubricants, use only recommended grade.

### For safe operation

- Do not Run the engine with the air cleaner disconnected.
- Do not Start the tractor in an enclosed building unless the doors and windows are open for proper ventilation.
- Do not Operate the tractor or engine while lubricating or cleaning.
- Do not Temper with the fuel injection pump, (if the seal is broken) the warranty becomes void.
- Do not Allow the engine to idle for a long period.
- Do not Use the independent brakes for making turns on the highway or at high speeds.
- Do not Refuel the tractor with the engine running.
- Do not Start the engine with the PTO engaged.

Carefully read and follow the other instructions given in the Do's and DON'Ts maintenance booklet, to ensure maximum saving of oil.







# INTERNATIONAL TRACTORS LIMITED

VIII, Chak Gujran, P.O. Piplanwala, Jalandhar Road, Hoshiarpur

## TRACTOR INSTALLATION CERTIFICATE

TRACTOR DETAILS	OWNER'S DETAILS
Engine No _____	Name _____
Chassis No: _____	Address _____
FIP No. _____	_____
Gear Box No. _____	Phone No _____
Alternator Make and No. _____	Tractor el:- _____
Hydraulic Pump No. _____	Mod ber:- _____
Battery Make and No. _____	Invoice a:- _____
a Tyre Details r. Nos) :- _____	Num e:- _____
(S _____ Right _____	Invoice Datther tractor owned (if any)
Front : Left _____ Right _____	Invoice _____

### LIST OF INSTRUCTIONS TO BE UNDERSTOOD AND FOLLOWED

S.No	Instructions	Tick here
1	Use of Operator's handbook	
2	Location & Significance of Engine No. Chassis No. etc	
3	Starting and Stopping Procedure	
4	Safety Precautions to be observed	
5	Use and adjustment of Clutch & Brake Pedals	
6	Running of New Tractor for first 100 hrs	
7	Maintainence of correct Tyre Pressure	
8	Operation of Hydraulic System & Adjustment of three point linkage & Mast height setting	
9	Selection of proper gears for different jobs and method	
10	Attachment & Detachment of Implements/Use of lift lock for transportation implements	
11	Setting of Wheel Track width for different crops	
12	Hitching of Trailer/Trolley & Use of Accessories	
13	Lubrication Points and correct grade of lubricants	
14	Periodic Replacement of fuel filters, oil filters, hydraulic filter	
15	Procedure for bleeding Fuel System	
16	Proper handling and storage of fuel	
17	Maintainence of Cooling System, Fan Belt Adjustment	
18	Maintainence of Electrical Equipments	
19	Tightening of bolts and nuts	
20	Daily and Weekly Maintainence Schedule	
21	Terms and conditions of warranty	
22	Availing of Free Service from Authorised Dealer	

Upload Photograph of Customer with Tractor & Impliments taken during installation	Maioir Application (₹ )		Accessories received (₹ )	
	Cultivation		Drawbar	
Rotavator		Bumper		
Haulage		Hook		
Genset		Top link		
Loader Dozer		Tool kit		
Grass cutter		Operator manual		
		Front Weights		
		Wheel Weights		

I hereby certify that I have understood all the instructions mentioned in this Certificate regarding Tractor maintenance and Proper use of all controls. I understand that Warranty starts from today, whose terms and conditions have been explained to me and are acceptable to me. I have carefully read all the instructions necessary for maintainence and proper use of Tractor. I will follow all the instructions, failing which my Warranty will stand cancelled.

Dealer representative Name & Signature	Customer Name & Signature
Dealership Name:-	Installation Date:-
Dealership Phone No.	Dealership Address:-

# Red



## INTERNATIONAL TRACTORS LIMITED

Village: Chak Gujran, P.O. Piplanwala, Jalandhar Road, Hoshiarpur

### TRACTOR INSTALLATION CERTIFICATE

TRACTOR DETAILS	OWNER'S DETAILS
Engine No _____	Name _____
Chassis No: _____	Address _____
FIP No. _____	Phone No _____
Gear Box No. _____	Tractor Model: _____
Alternator Make and No. _____	Mod No: _____
Hydraulic Pump No. _____	Invoice No: _____
Battery Make and No. _____	Num of tractors owned (if any) _____
Tyre Details (r. Nos) :- (S _____ Right _____ Front : Left _____ Right _____	Invoice Date _____

#### LIST OF INSTRUCTIONS TO BE UNDERSTOOD AND FOLLOWED

S.No	Instructions	Tick here
1	Use of Operator's handbook	
2	Location & Significance of Engine No. Chassis No. etc	
3	Starting and Stopping Procedure	
4	Safety Precautions to be observed	
5	Use and adjustment of Clutch & Brake Pedals	
6	Running of New Tractor for first 100 hrs	
7	Maintainence of correct Tyre Pressure	
8	Operation of Hydraulic System & Adjustment of three point linkage & Mast height setting	
9	Selection of proper gears for different jobs and method	
10	Attachment & Detachment of Implements/Use of lift lock for transportation implements	
11	Setting of Wheel Track width for different crops	
12	Hitching of Trailer/Trolley & Use of Accessories	
13	Lubrication Points and correct grade of lubricants	
14	Periodic Replacement of fuel filters, oil filters, hydraulic filter	
15	Procedure for bleeding Fuel System	
16	Proper handling and storage of fuel	
17	Maintainence of Cooling System, Fan Belt Adjustment	
18	Maintainence of Electrical Equipments	
19	Tightening of bolts and nuts	
20	Daily and Weekly Maintainence Schedule	
21	Terms and conditions of warranty	
22	Availing of Free Service from Authorised Dealer	

Upload Photograph of Customer with Tractor & Implements taken during installation	<b>Major Application (₹ )</b>	<b>Accessories received (₹ )</b>
	Cultivation	Drawbar
	Rotavator	Bumper
	Haulage	Hook
	Genset	Top link
	Loader Dozer	Tool kit
	Grass cutter	Operator manual
		Front Weights
	Wheel Weights	

*I hereby certify that I have understood all the instructions mentioned in this Certificate regarding Tractor maintenance and Proper use of all controls. I understand that Warranty starts from today, whose terms and conditions have been explained to me and are acceptable to me. I have carefully read all the instructions necessary for maintainence and proper use of Tractor. I will follow all the instructions, failing which my Warranty will stand cancelled.*

Dealer representative Name & Signature	Customer Name & Signature
Dealership Name:-	Installation Date:-
Dealership Phone No.	Dealership Address:-

DEALER COPY



## INTERNATIONAL TRACTORS LIMITED

Village, Chak Gujran, P.O. Piplanwala, Jalandhar Road, Hoshiarpur

## TRACTOR INSTALLATION CERTIFICATE

TRACTOR DETAILS		OWNER'S DETAILS	
Engine No	_____	Name	_____
Chassis No:	_____	Address	_____
FIP No.	_____		_____
Gear Box No.	_____	Phone No	_____
Alternator Make and No.	_____	Tractor	el:- _____
Hydraulic Pump No.	_____	Mod	ber:- _____
Battery Make and No.	_____	Invoice	e:- _____
a Tyre Details (r. Nos) :-	_____	Num	e:- _____
(S _____ Right _____		Invoice	Datther tractor owned (if any)
Front : Left _____ Right _____		Invoice	_____
LIST OF INSTRUCTIONS TO BE UNDERSTOOD AND FOLLOWED			
S.No	Instructions	Tick here	
1	Use of Operator's handbook		
2	Location & Significance of Engine No. Chassis No. etc		
3	Starting and Stopping Procedure		
4	Safety Precautions to be observed		
5	Use and adjustment of Clutch & Brake Pedals		
6	Running of New Tractor for first 100 hrs		
7	Maintainence of correct Tyre Pressure		
8	Operation of Hydraulic System & Adjustment of three point linkage & Mast height setting		
9	Selection of proper gears for different jobs and method		
10	Attachment & Detachment of Implements/Use of lift lock for transportation implements		
11	Setting of Wheel Track width for different crops		
12	Hitching of Trailer/Trolley & Use of Accessories		
13	Lubrication Points and correct grade of lubricants		
14	Periodic Replacement of fuel filters, oil filters, hydraulic filter		
15	Procedure for bleeding Fuel System		
16	Proper handling and storage of fuel		
17	Maintainence of Cooling System, Fan Belt Adjustment		
18	Maintainence of Electrical Equipments		
19	Tightening of bolts and nuts		
20	Daily and Weekly Maintainence Schedule		
21	Terms and conditions of warranty		
22	Availing of Free Service from Authorised Dealer		
Upload Photograph of Customer with Tractor & Impliments taken during installation		Maior Application (₹ )	
		Cultivation	_____
		Rotavator	_____
		Haulage	_____
		Genset	_____
		Loader Dozer	_____
		Grass cutter	_____
			_____
Accessories received (₹ )			
Drawbar	_____		
Bumper	_____		
Hook	_____		
Top link	_____		
Tool kit	_____		
Operator manual	_____		
Front Weights	_____		
Wheel Weights	_____		
I hereby certify that I have understood all the instructions mentioned in this Certificate regarding Tractor maintenance and Proper use of all controls. I understand that Warranty starts from today, whose terms and conditions have been explained to me and are acceptable to me. I have carefully read all the instructions necessary for maintainence and proper use of Tractor. I will follow all the instructions, failing which my Warranty will stand cancelled.			
Dealer representative Name & Signature		Customer Name & Signature	
Dealership Name:-		Installation Date:-	
Dealership Phone No.		Dealership Address:-	



**International Tractors Limited**  
 Jalandhar Rd. Hoshiarpur- (Pb). 146 001  
 Phones: +91-1882- 302220, 302221, 302223

Date: \_\_\_\_\_  
 Dealer Code: \_\_\_\_\_  
 Model: \_\_\_\_\_  
 Chassis No. \_\_\_\_\_  
 Engine No. \_\_\_\_\_  
 HMR \_\_\_\_\_

I here by certify that the service has been carried out to my entire satisfaction as per company recommended schedule.

Owner / Operator signature .....  
 Owner / Operator Name .....

Dealer stamp & signature:.....

Payment towards all consumables (All lub. /oils, bulb, etc.) will be borne by customer



**International Tractors Limited**  
 Jalandhar Rd. Hoshiarpur- (Pb). 146 001  
 Phones: +91-1882- 302220, 302221, 302223

Date: \_\_\_\_\_  
 Dealer Code: \_\_\_\_\_  
 Model: \_\_\_\_\_  
 Chassis No. \_\_\_\_\_  
 Engine No. \_\_\_\_\_  
 HMR \_\_\_\_\_

I here by certify that the service has been carried out to my entire satisfaction as per company recommended schedule.

Owner / Operator signature .....  
 Owner / Operator Name .....

Dealer stamp & signature:.....

Payment towards all consumables (All lub. /oils, bulb, etc.) will be borne by customer



**International Tractors Limited**  
 Jalandhar Rd. Hoshiarpur- (Pb). 146 001  
 Phones: +91-1882- 302220, 302221, 302223

Date: \_\_\_\_\_  
 Dealer Code: \_\_\_\_\_  
 Model: \_\_\_\_\_  
 Chassis No. \_\_\_\_\_  
 Engine No. \_\_\_\_\_  
 HMR \_\_\_\_\_

I here by certify that the service has been carried out to my entire satisfaction as per company recommended schedule.

Owner / Operator signature .....  
 Owner / Operator Name .....

Dealer stamp & signature:.....

Payment towards all consumables (All lub. /oils, bulb, etc.) will be borne by customer



**International Tractors Limited**  
 Jalandhar Rd. Hoshiarpur- (Pb). 146 001  
 Phones: +91-1882- 302220, 302221, 302223

Date: \_\_\_\_\_  
 Dealer Code: \_\_\_\_\_  
 Model: \_\_\_\_\_  
 Chassis No. \_\_\_\_\_  
 Engine No. \_\_\_\_\_  
 HMR \_\_\_\_\_

I here by certify that the service has been carried out to my entire satisfaction as per company recommended schedule.

Owner / Operator signature .....  
 Owner / Operator Name .....

Dealer stamp & signature:.....

Payment towards all consumables (All lub. /oils, bulb, etc.) will be borne by customer

### JOBS TO BE PERFORMED DURING 60 HOURS SERVICE

Operations	Check Points	Tick
<b>Washing</b>	Complete Tractor.	
<b>Lubrication</b>	Lubricate all grease nipples.	
<b>Oil Change</b>	<b>(Sonalika Maxima)</b> Engine Oil.	
	Air cleaner oil.	
<b>Check &amp; Top up</b>	Coolant Level.	
	Electrolyte level of battery.	
	Oil level in steering box.	
<b>Check &amp; Adjust</b>	Tappet clearance.	
	Brake & Clutch pedal free play.	
	Belt Tension(10mm)	
	Idle RPM/Max RPM.	
<b>Check</b>	Toe-In & Tyre pressure.	
	Functioning of oil & temp. gauge.	
	Air cleaner Oil /Air Filter	
	Tightness of all bolts & nuts.	
<b>Clean</b>	FIP feed pump bowl.	
	Vent plugs & terminals of battery.	
	Air cleaner element Wet / Dry.	
	Fuel Cock strainer.	
	Water separator	
	Lubrication oil filter & hyd. oil filter.	
<b>Change</b>	Engine & Bell Hsg M12*1.75*40	
<b>Torquing</b>	/M10*1.5 70/40 Nm Front axle bolts 140 to 150 NM	

### JOBS TO BE PERFORMED DURING 60 HOURS SERVICE

Operations	Check Points	Tick
<b>Washing</b>	Complete Tractor.	
<b>Lubrication</b>	Lubricate all grease nipples.	
<b>Oil Change</b>	<b>(Sonalika Maxima)</b> Engine Oil.	
	Air cleaner oil.	
<b>Check &amp; Top up</b>	Coolant Level.	
	Electrolyte level of battery.	
	Oil level in steering box.	
<b>Check &amp; Adjust</b>	Tappet clearance.	
	Brake & Clutch pedal free play.	
	Belt Tension(10mm)	
	Idle RPM/Max RPM.	
<b>Check</b>	Toe-In & Tyre pressure.	
	Functioning of oil & temp. gauge.	
	Air cleaner Oil /Air Filter	
	Tightness of all bolts & nuts.	
<b>Clean</b>	FIP feed pump bowl.	
	Vent plugs & terminals of battery.	
	Air cleaner element Wet / Dry.	
	Fuel Cock strainer.	
	Water separator	
	Lubrication oil filter & hyd. oil filter.	
<b>Change</b>	Engine & Bell Hsg M12*1.75*40	
<b>Torquing</b>	/M10*1.5 70/40 Nm Front axle bolts 140 to 150 NM	

Operations	Check Points	Tick
<b>Washing</b>	Complete Tractor.	
<b>Lubrication</b>	Lubricate all grease nipples.	
<b>Oil Change</b>	<b>(Sonalika Maxima)</b> Engine Oil.	
	Air cleaner oil.	
<b>Check &amp; Top up</b>	Coolant Level.	
	Electrolyte level of battery.	
	Oil level in steering box.	
<b>Check &amp; Adjust</b>	Tappet clearance.	
	Brake & Clutch pedal free play.	
	Belt Tension (10mm)	
	Idle RPM/Max RPM.	
<b>Check</b>	Toe-In & Tyre pressure.	
	Functioning of oil & temp. gauge.	
	Air cleaner Oil/Air Filter	
	Tightness of all bolts & nuts.	
<b>Clean</b>	FIP feed pump bowl.	
	Vent plugs & terminals of battery.	
	Air cleaner element Wet / Dry.	
	Fuel Cock strainer.	
	Water separator	
	Lubrication oil filter & hyd. oil filter.	
<b>Change</b>	Engine & Bell Hsg M12*1.75*40	
<b>Torquing</b>	/M10*1.5 70/40 Nm Front axle bolts 140 to 150 NM	

Operations	Check Points	Tick
<b>Washing</b>	Complete Tractor.	
<b>Lubrication</b>	Lubricate all grease nipples.	
<b>Oil Change</b>	<b>(Sonalika Maxima)</b> Engine Oil.	
	Air cleaner oil.	
<b>Check &amp; Top up</b>	Coolant Level.	
	Electrolyte level of battery.	
	Oil level in steering box.	
<b>Check &amp; Adjust</b>	Tappet clearance.	
	Brake & Clutch pedal free play.	
	Belt Tension (10mm)	
	Idle RPM/Max RPM.	
<b>Check</b>	Toe-In & Tyre pressure.	
	Functioning of oil & temp. gauge.	
	Air cleaner Oil/Air Filter	
	Tightness of all bolts & nuts.	
<b>Clean</b>	FIP feed pump bowl.	
	Vent plugs & terminals of battery.	
	Air cleaner element Wet / Dry.	
	Fuel Cock strainer.	
	Water separator	
	Lubrication oil filter & hyd. oil filter.	
<b>Change</b>	Engine & Bell Hsg M12*1.75*40	
<b>Torquing</b>	/M10*1.5 70/40 Nm Front axle bolts 140 to 150 NM	

**JOBS TO BE PERFORMED DURING 260 HOURS SERVICE**

**JOBS TO BE PERFORMED DURING 260 HOURS SERVICE**



**International Tractors Limited**  
 Jalandhar Rd. Hoshiarpur- (Pb). 146 001  
 Phones: +91-1882- 302220, 302221, 302223

Date: \_\_\_\_\_  
 Dealer Code: \_\_\_\_\_  
 Model: \_\_\_\_\_  
 Chassis No. \_\_\_\_\_  
 Engine No. \_\_\_\_\_  
 HMR \_\_\_\_\_

I here by certify that the service has been carried out to my entire satisfaction as per company recommended schedule.

Owner / Operator signature .....  
 Owner / Operator Name .....

Dealer stamp & signature:.....

Payment towards all consumables (All lub. /oils, bulb, etc.) will be borne by customer



**International Tractors Limited**  
 Jalandhar Rd. Hoshiarpur- (Pb). 146 001  
 Phones: +91-1882- 302220, 302221, 302223

Date: \_\_\_\_\_  
 Dealer Code: \_\_\_\_\_  
 Model: \_\_\_\_\_  
 Chassis No. \_\_\_\_\_  
 Engine No. \_\_\_\_\_  
 HMR \_\_\_\_\_

I here by certify that the service has been carried out to my entire satisfaction as per company recommended schedule.

Owner / Operator signature .....  
 Owner / Operator Name .....

Dealer stamp & signature:.....

Payment towards all consumables (All lub. /oils, bulb, etc.) will be borne by customer



**International Tractors Limited**  
 Jalandhar Rd. Hoshiarpur- (Pb). 146 001  
 Phones: +91-1882- 302220, 302221, 302223

Date: \_\_\_\_\_  
 Dealer Code: \_\_\_\_\_  
 Model: \_\_\_\_\_  
 Chassis No. \_\_\_\_\_  
 Engine No. \_\_\_\_\_  
 HMR \_\_\_\_\_

I here by certify that the service has been carried out to my entire satisfaction as per company recommended schedule.

Owner / Operator signature .....  
 Owner / Operator Name .....

Dealer stamp & signature:.....

Payment towards all consumables (All lub. /oils, bulb, etc.) will be borne by customer



**International Tractors Limited**  
 Jalandhar Rd. Hoshiarpur- (Pb). 146 001  
 Phones: +91-1882- 302220, 302221, 302223

Date: \_\_\_\_\_  
 Dealer Code: \_\_\_\_\_  
 Model: \_\_\_\_\_  
 Chassis No. \_\_\_\_\_  
 Engine No. \_\_\_\_\_  
 HMR \_\_\_\_\_

I here by certify that the service has been carried out to my entire satisfaction as per company recommended schedule.

Owner / Operator signature .....  
 Owner / Operator Name .....

Dealer stamp & signature:.....

Payment towards all consumables (All lub. /oils, bulb, etc.) will be borne by customer



### JOB TO BE PERFORMED DURING 510 HOURS SERVICE

Operations	Check Points	Tick
<b>Washing</b>	Complete Tractor.	
<b>Lubrication</b>	Lubricate all grease nipples.	
<b>Oil Change</b>	(Sonalika Maxima) Engine Oil.	
	Air cleaner oil.	
<b>Check &amp; Top up</b>	Coolant Level.	
	Electrolyte level of battery.	
	Oil level in steering box.	
<b>Check &amp; Adjust</b>	Tappet clearance.	
	Brake & Clutch pedal free play.	
	Belt Tension(10mm)	
	Idle RPM/Max RPM.	
<b>Check</b>	Toe-In & Tyre pressure.	
	Functioning of oil & temp. gauge.	
	Air cleaner Oil /Air Filter	
	Tightness of all bolts & nuts.	
<b>Clean</b>	FIP feed pump bowl.	
	Vent plugs & terminals of battery.	
	Air cleaner element Wet / Dry.	
	Fuel Cock strainer.	
	Water separator	
	Lubrication oil filter & hyd. oil filter.	
<b>Change</b>	Engine & Bell Hsg M12*1.75*40	
<b>Torquing</b>	/M10*1.5 70/40 Nm Front axle bolts 150 to 180 NM	

### JOB TO BE PERFORMED DURING 510 HOURS SERVICE

Operations	Check Points	Tick
<b>Washing</b>	Complete Tractor.	
<b>Lubrication</b>	Lubricate all grease nipples.	
<b>Oil Change</b>	(Sonalika Maxima) Engine Oil.	
	Air cleaner oil.	
<b>Check &amp; Top up</b>	Coolant Level.	
	Electrolyte level of battery.	
	Oil level in steering box.	
<b>Check &amp; Adjust</b>	Tappet clearance.	
	Brake & Clutch pedal free play.	
	Belt Tension(10mm)	
	Idle RPM/Max RPM.	
<b>Check</b>	Toe-In & Tyre pressure.	
	Functioning of oil & temp. gauge.	
	Air cleaner Oil /Air Filter	
	Tightness of all bolts & nuts.	
<b>Clean</b>	FIP feed pump bowl.	
	Vent plugs & terminals of battery.	
	Air cleaner element Wet / Dry.	
	Fuel Cock strainer.	
	Water separator	
	Lubrication oil filter & hyd. oil filter.	
<b>Change</b>	Engine & Bell Hsg M12*1.75*40	
<b>Torquing</b>	/M10*1.5 70/40 Nm Front axle bolts 150 to 180 NM	

Operations	Check Points	Tick
<b>Washing</b>	Complete Tractor.	
<b>Lubrication</b>	Lubricate all grease nipples.	
<b>Oil Change</b>	(Sonalika Maxima) Engine Oil.	
	Air cleaner oil.	
<b>Check &amp; Top up</b>	Coolant Level.	
	Electrolyte level of battery.	
	Oil level in steering box.	
<b>Check &amp; Adjust</b>	Tappet clearance.	
	Brake & Clutch pedal free play.	
	Belt Tension(10mm)	
	Idle RPM/Max RPM.	
<b>Check</b>	Toe-In & Tyre pressure.	
	Functioning of oil & temp. gauge.	
	Air cleaner Oil /Air Filter	
	Tightness of all bolts & nuts.	
<b>Clean</b>	FIP feed pump bowl.	
	Vent plugs & terminals of battery.	
	Air cleaner element Wet / Dry.	
	Brake housing / lining.	
	Fuel Cock strainer.	
	Water separator	
<b>Change</b>	Lubrication oil filter & hyd. oil filter.	
<b>Torquing</b>	Engine & Bell Hsg M12*1.75*40 /M10*1.5 70/40 Nm Front axle bolts 150 to 180 NM	

Operations	Check Points	Tick
<b>Washing</b>	Complete Tractor.	
<b>Lubrication</b>	Lubricate all grease nipples.	
<b>Oil Change</b>	(Sonalika Maxima) Engine Oil.	
	Air cleaner oil.	
<b>Check &amp; Top up</b>	Coolant Level.	
	Electrolyte level of battery.	
	Oil level in steering box.	
<b>Check &amp; Adjust</b>	Tappet clearance.	
	Brake & Clutch pedal free play.	
	Belt Tension(10mm)	
	Idle RPM/Max RPM.	
<b>Check</b>	Toe-In & Tyre pressure.	
	Functioning of oil & temp. gauge.	
	Air cleaner Oil /Air Filter	
	Tightness of all bolts & nuts.	
<b>Clean</b>	FIP feed pump bowl.	
	Vent plugs & terminals of battery.	
	Air cleaner element Wet / Dry.	
	Brake housing / lining.	
	Fuel Cock strainer.	
	Water separator	
<b>Change</b>	Lubrication oil filter & hyd. oil filter.	
<b>Torquing</b>	Engine & Bell Hsg M12*1.75*40 /M10*1.5 70/40 Nm Front axle bolts 150 to 180 NM	

**JOBS TO BE PERFORMED DURING 760 HOURS SERVICE**

**JOBS TO BE PERFORMED DURING 760 HOURS SERVICE**



**International Tractors Limited**  
 Jalandhar Rd. Hoshiarpur- (Pb). 146 001  
 Phones: +91-1882- 302220, 302221, 302223

Date: \_\_\_\_\_  
 Dealer Code: \_\_\_\_\_  
 Model: \_\_\_\_\_  
 Chassis No. \_\_\_\_\_  
 Engine No. \_\_\_\_\_  
 HMR \_\_\_\_\_

I here by certify that the service has been carried out to my entire satisfaction as per company recommended schedule.

Owner / Operator signature .....  
 Owner / Operator Name .....

Dealer stamp & signature:.....

Payment towards all consumables (All lub. /oils, bulb, etc.) will be borne by customer



**International Tractors Limited**  
 Jalandhar Rd. Hoshiarpur- (Pb). 146 001  
 Phones: +91-1882- 302220, 302221, 302223

Date: \_\_\_\_\_  
 Dealer Code: \_\_\_\_\_  
 Model: \_\_\_\_\_  
 Chassis No. \_\_\_\_\_  
 Engine No. \_\_\_\_\_  
 HMR \_\_\_\_\_

I here by certify that the service has been carried out to my entire satisfaction as per company recommended schedule.

Owner / Operator signature .....  
 Owner / Operator Name .....

Dealer stamp & signature:.....

Payment towards all consumables (All lub. /oils, bulb, etc.) will be borne by customer



**International Tractors Limited**  
 Jalandhar Rd. Hoshiarpur- (Pb). 146 001  
 Phones: +91-1882- 302220, 302221, 302223

Date: \_\_\_\_\_  
 Dealer Code: \_\_\_\_\_  
 Model: \_\_\_\_\_  
 Chassis No. \_\_\_\_\_  
 Engine No. \_\_\_\_\_  
 HMR \_\_\_\_\_

I here by certify that the service has been carried out to my entire satisfaction as per company recommended schedule.

Owner / Operator signature .....  
 Owner / Operator Name .....

Dealer stamp & signature:.....

Payment towards all consumables (All lub. /oils, bulb, etc.) will be borne by customer



**International Tractors Limited**  
 Jalandhar Rd. Hoshiarpur- (Pb). 146 001  
 Phones: +91-1882- 302220, 302221, 302223

Date: \_\_\_\_\_  
 Dealer Code: \_\_\_\_\_  
 Model: \_\_\_\_\_  
 Chassis No. \_\_\_\_\_  
 Engine No. \_\_\_\_\_  
 HMR \_\_\_\_\_

I here by certify that the service has been carried out to my entire satisfaction as per company recommended schedule.

Owner / Operator signature .....  
 Owner / Operator Name .....

Dealer stamp & signature:.....

Payment towards all consumables (All lub. /oils, bulb, etc.) will be borne by customer

### JOB TO BE PERFORMED DURING 1010 HOURS SERVICE

Operations	Check Points	Tick
Washing	Complete Tractor.	
Lubrication	Lubricate all grease nipples.	
Oil Change	(Sonalika Maxima) Engine Oil.	
	Transmission oil	
	Air cleaner oil.	
Check & Top up	Coolant Level.	
	Electrolyte level of battery.	
	Oil level in steering box.	
Check & Adjust	Tappet clearance.	
	Brake & Clutch pedal free play.	
	Belt Tension 10mm	
	Idle RPM/Max RPM.	
Check	Toe-In & Tyre pressure.	
	Functioning of oil & temp. gauge.	
	Air cleaner, Oil/Air Filter	
	Tightness of all bolts & nuts.	
Clean	FIP feed pump bowl.	
	Vent plugs & terminals of battery.	
	Air cleaner element Wet / Dry.	
	Fuel Cock strainer.	
	Water separator	
Change	Lubrication oil filter & hyd. oil filter	
	Engine & Bell Hsg M12*1.75*40	
Torquing	/M10*1.5 70/40 Nm	
	Front axle bolts 150 to 180 NM	

### JOB TO BE PERFORMED DURING 1010 HOURS SERVICE

Operations	Check Points	Tick
Washing	Complete Tractor.	
Lubrication	Lubricate all grease nipples.	
Oil Change	(Sonalika Maxima) Engine Oil.	
	Transmission oil	
	Air cleaner oil.	
Check & Top up	Coolant Level.	
	Electrolyte level of battery.	
	Oil level in steering box.	
Check & Adjust	Tappet clearance.	
	Brake & Clutch pedal free play.	
	Belt Tension 10mm	
	Idle RPM/Max RPM.	
Check	Toe-In & Tyre pressure.	
	Functioning of oil & temp. gauge.	
	Air cleaner, Oil/Air Filter	
	Tightness of all bolts & nuts.	
Clean	FIP feed pump bowl.	
	Vent plugs & terminals of battery.	
	Air cleaner element Wet / Dry.	
	Fuel Cock strainer.	
	Water separator	
Change	Lubrication oil filter & hyd. oil filter	
	Engine & Bell Hsg M12*1.75*40	
Torquing	/M10*1.5 70/40 Nm	
	Front axle bolts 150 to 180 NM	

Operations	Check Points	Tick
Washing	Complete Tractor.	
Lubrication	Lubricate all grease nipples.	
Oil Change	(Sonalika Maxima) Engine Oil.	
	Air cleaner oil.	
Check & Top up	Coolant Level.	
	Electrolyte level of battery.	
	Oil level in steering box.	
Check & Adjust	Tappet clearance.	
	Brake & Clutch pedal free play.	
	Belt Tension(10mm)	
	Idle RPM/Max RPM.	
Check	Toe-In & Tyre pressure.	
	Functioning of oil & temp. gauge.	
	Air cleaner Oil /Air Filter	
	Tightness of all bolts & nuts.	
Clean	FIP feed pump bowl.	
	Vent plugs & terminals of battery.	
	Air cleaner element Wet / Dry.	
	Fuel Cock strainer.	
	Water separator	
Change	Lubrication oil filter & hyd. oil filter.	
	Engine & Bell Hsg M12*1.75*40	
Torquing	/M10*1.5 70/40 Nm	
	Front axle bolts 150 to 180 NM	

Operations	Check Points	Tick
Washing	Complete Tractor.	
Lubrication	Lubricate all grease nipples.	
Oil Change	(Sonalika Maxima) Engine Oil.	
	Air cleaner oil.	
Check & Top up	Coolant Level.	
	Electrolyte level of battery.	
	Oil level in steering box.	
Check & Adjust	Tappet clearance.	
	Brake & Clutch pedal free play.	
	Belt Tension(10mm)	
	Idle RPM/Max RPM.	
Check	Toe-In & Tyre pressure.	
	Functioning of oil & temp. gauge.	
	Air cleaner Oil /Air Filter	
	Tightness of all bolts & nuts.	
Clean	FIP feed pump bowl.	
	Vent plugs & terminals of battery.	
	Air cleaner element Wet / Dry.	
	Fuel Cock strainer.	
	Water separator	
Change	Lubrication oil filter & hyd. oil filter.	
	Engine & Bell Hsg M12*1.75*40	
Torquing	/M10*1.5 70/40 Nm	
	Front axle bolts 150 to 180 NM	

**JOBS TO BE PERFORMED DURING 1260 HOURS SERVICE**

**JOBS TO BE PERFORMED DURING 1260 HOURS SERVICE**



**International Tractors Limited**  
 Jalandhar Rd. Hoshiarpur- (Pb). 146 001  
 Phones: +91-1882- 302220, 302221, 302223



**International Tractors Limited**  
 Jalandhar Rd. Hoshiarpur- (Pb). 146 001  
 Phones: +91-1882- 302220, 302221, 302223

Date: \_\_\_\_\_  
 Dealer Code: \_\_\_\_\_  
 Model: \_\_\_\_\_  
 Chassis No. \_\_\_\_\_  
 Engine No. \_\_\_\_\_  
 HMR \_\_\_\_\_

Date: \_\_\_\_\_  
 Dealer Code: \_\_\_\_\_  
 Model: \_\_\_\_\_  
 Chassis No. \_\_\_\_\_  
 Engine No. \_\_\_\_\_  
 HMR \_\_\_\_\_

I here by certify that the service has been carried out to my entire satisfaction as per company recommended schedule.

I here by certify that the service has been carried out to my entire satisfaction as per company recommended schedule.

Owner / Operator signature .....  
 Owner / Operator Name .....

Owner / Operator signature .....  
 Owner / Operator Name .....

Dealer stamp & signature:.....

Dealer stamp & signature:.....

Payment towards all consumables (All lub. /oils, bulb, etc.) will be borne by customer

Payment towards all consumables (All lub. /oils, bulb, etc.) will be borne by customer

### JOB TO BE PERFORMED DURING 1500 HOURS SERVICE

Operations	Check Points	Tick
<b>Washing</b>	Complete Tractor.	
<b>Lubrication</b>	Lubricate all grease nipples.	
<b>Oil Change</b>	<b>(Sonalika Maxima)</b> Engine Oil.	
	Air cleaner oil.	
<b>Check &amp; Top up</b>	Coolant Level.	
	Electrolyte level of battery.	
	Oil level in steering box.	
<b>Check &amp; Adjust</b>	Tappet clearance.	
	Brake & Clutch pedal free play.	
	Belt Tension(10mm)	
	Idle RPM/Max RPM.	
<b>Check</b>	Toe-In & Tyre pressure.	
	Functioning of oil & temp. gauge.	
	Air cleaner Oil /Air Filter	
	Tightness of all bolts & nuts.	
<b>Clean</b>	FIP feed pump bowl.	
	Vent plugs & terminals of battery.	
	Air cleaner element Wet / Dry.	
	Brake housing / lining.	
	Fuel Cock strainer.	
<b>Change</b>	Water separator	
	Lubrication oil filter & hyd. oil filter.	
<b>Torquing</b>	Engine & Bell Hsg M12*1.75*40	
	/M10*1.5 70/40 Nm	
	Front axle bolts 150 to 180 NM	

### JOB TO BE PERFORMED DURING 1500 HOURS SERVICE

Operations	Check Points	Tick
<b>Washing</b>	Complete Tractor.	
<b>Lubrication</b>	Lubricate all grease nipples.	
<b>Oil Change</b>	<b>(Sonalika Maxima)</b> Engine Oil.	
	Air cleaner oil.	
<b>Check &amp; Top up</b>	Coolant Level.	
	Electrolyte level of battery.	
	Oil level in steering box.	
<b>Check &amp; Adjust</b>	Tappet clearance.	
	Brake & Clutch pedal free play.	
	Belt Tension(10mm)	
	Idle RPM/Max RPM.	
<b>Check</b>	Toe-In & Tyre pressure.	
	Functioning of oil & temp. gauge.	
	Air cleaner Oil /Air Filter	
	Tightness of all bolts & nuts.	
<b>Clean</b>	FIP feed pump bowl.	
	Vent plugs & terminals of battery.	
	Air cleaner element Wet / Dry.	
	Brake housing / lining.	
	Fuel Cock strainer.	
<b>Change</b>	Water separator	
	Lubrication oil filter & hyd. oil filter.	
<b>Torquing</b>	Engine & Bell Hsg M12*1.75*40	
	/M10*1.5 70/40 Nm	
	Front axle bolts 150 to 180 NM	





## 10. TROUBLE SHOOTING

PROBLEM	POSSIBLE CAUSE	REMEDY
<b>ENGINE</b>		
<b>Engine not starting</b>	Wrong way of starting engine	Use proper way of starting
	No fuel	Check Fuel level
	Air trapped in fuel system	Bleed the fuel system
	Checking of fuel system	Contact your dealer
	Fuel injector faulty	Replace
	Pull to lever knob in pulling condition	Return it to its proper position
	Fuel filter choke	Replace filters
<b>Engine not run in proper way</b>	Fuel filter choke	Replace filters
	Low quality of oil	Drain diesel from tank and fill clean diesel
	Choking of fuel system	Check fuel system
	Fuel injectors faulty	Replace fuel injector
<b>More oil consumption</b>	Oil level is more than maximum level	Keep oil level up to mark
	Oil quality is not good	Use genuine oil
<b>Engine not giving maximum power</b>	Leakage of oil	Check and repair
	Heavy load on engine	Decrease load or shift in low gear
	Air cleaner dirty	Clean air cleaner
	Fuel filter choke	Replace filter
	Engine overheating	Check cooling system
	Engine operating temperature is less	Check thermostat
	Valve clearance not proper	Adjust through authorized dealer.
	Throttle system not working properly	Check & repair through authorized dealer.
<b>Engine abnormal noise</b>	Oil level less	Top up
	Oil pressure less	Check through authorized dealer
	Engine is overheated	Check and find reason
	Improper tappet setting	Adjust through authorized dealer
<b>Oil pressure Indicator shows warning</b>	Oil level is less	Top up oil up to level
	Oil quality is not good	Use genuine engine oil
	Oil pump not working	Check and repair through authorized dealer
<b>Engine Over Heating</b>	Radiator cap faulty	Replace with new one
	Choked radiator fins	Clean it
	Engine gets overload	Decrease load or shift to low gear
	Oil level is less	Top up to level
	Coolant level is less	Check level and leakage of system and top up
	Slippage of fan belt	Check belt tension
	Thermostat faulty	Replace
	Choking of cooling system	Clean the cooling system
	Water temp. Gauge not working	Check through dealer and faulty replace

PROBLEM	POSSIBLE CAUSE	REMEDY
<b>ENGINE</b>		
<b>More Fuel Consumption</b>	Air cleaner is dirty / choked	Clean air cleaner
	Overloading of engine	Reduce load or shift to low gear
	Improper valve clearance	Check and adjust
	Implement setting improper	Adjust it and take instrument from dealer for right
	Less engine temp	Check injectors and service
	Fuel injection nozzle faulty	Check and service through dealer
<b>HYDRAULIC</b>		
<b>Excessive Heating of Oil</b>	Improper inflation pressure	Check and adjust according to specified
	Oil level is high or less	Check and maintain proper level
	Hydraulic Strainer choked	Clean/Replace
	Mechanical linkage may faulty	Contact your authorized dealer
<b>Linkage Goes Down Slowly</b>	Bush tight	Contact your authorized dealer
	Response valve setting improper	Contact your authorized dealer
<b>Linkage Not Lift Fully</b>	Improper lift arm setting	Contact your authorized dealer
	Improper internal adjustment	Contact your authorized dealer
<b>TPL Not Respond To Lifting While Operating Hydraulic Lever</b>	Linkage connection not joint properly	Contact your authorized dealer
	Heavy load on linkage	Contact your authorized dealer
<b>Hydraulic System Not Working Properly</b>	Response valve setting very low	Check valve by your dealer.
	Oil level low	Check and top up
	Hydraulic Strainer choked	Clean/Replace
	Hydraulic system faulty	Check through authorized dealer
	Hydraulic pump not working	Contact your authorized dealer
<b>BRAKES</b>		
<b>Noise While Applying Brakes Tractor Goes in One Side</b>	Wrong adjustment of brakes	Check
	Both brakes are not set properly	Adjust
<b>Brakes Works When Fully Pressed</b>	Wrong adjustment of brake pedal	Check and Adjust.
<b>ELECTRICAL</b>		
<b>Electrical System Not Working</b>	Battery terminal loose or rusting of terminal	Clean and tight the terminals
	Less specific gravity	Replace or fill electrolyte up to level
<b>Starter Motor Not Working.</b>	Battery terminal loose / Battery discharged	Tightened / Recharge or replace battery
	Faulty starter motor	For repair contact your dealer
<b>Battery Not Charging</b>	Loose or rusted terminals	Clean and tight terminal
	Belt loose	Check belt tension
	Faulty battery	Replace

## 11. MATCHING IMPLEMENTS

### 11.1 SPECIFICATIONS

Tractor Model	Implement	Implement Size
Gardentrac 20HP	Rotavator	0.9 mtr. with 24 Blades (J Type) 1.1 mtr. with 28 Blades (J Type)
	Cultivator	5 Tines
	Harrow	5 x 5 Disc

### 11.2 CULTIVATOR

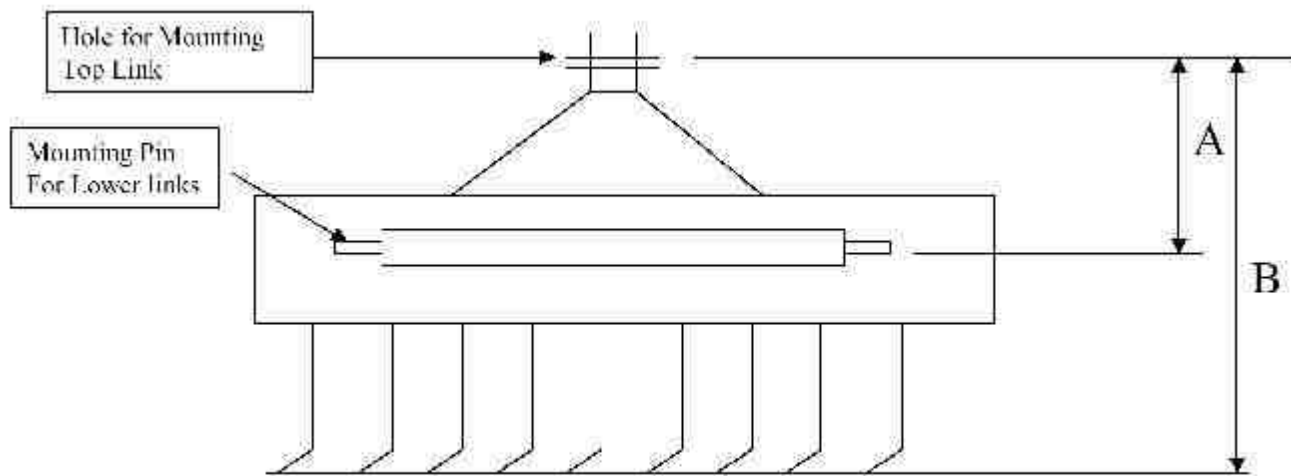

**A= Mast Height**

**B= Total Height From Ground**

Rear tyre	Mast Height, A	Ht from Ground, B	No of tynes
8 x18	19 inches	34 inches	5 tyne/ 7 tyne



## 11.3 ROTAVTOR

### 11.3.1 SAFETY PRECAUTIONS

1. The safety of the operator should be of prime consideration.
2. Please be advised only trained personnel except for owner-operator is allowed to use power equipment.
3. Don't operate your tractor with rotary tiller of which blade bolt is unfastened.
4. Be careful not to touch rotary tiller nor leave your tractor sheet while the rotary tiller is in operation. Don't fail to stop the engine before servicing of the rotary tiller, adjustment, maintenance (cleaning, greasing) and so on.
5. Avoid to operate universal joint at angle above  $10^{\circ}$  ~  $13^{\circ}$  which may cause vibration, damage or other troubles.
6. Be particular about operator's clothing. Loose clothing is caught in moving parts.
7. When operating the rotary tiller, read the operating manual of tractor carefully.
8. As the tractor with rotary tiller turns round in a large radius, be careful in its operation.

### 11.3.2 ASSEMBLING

1. Remove the top link bracket at the back side of the hydraulic lift case and fasten the chain bracket with the bolts which have been used for the Top link bracket. (Fig. 1)  
Tightening torque : 4 ~ 5kg-m (29 ~ 36 ft-lb)

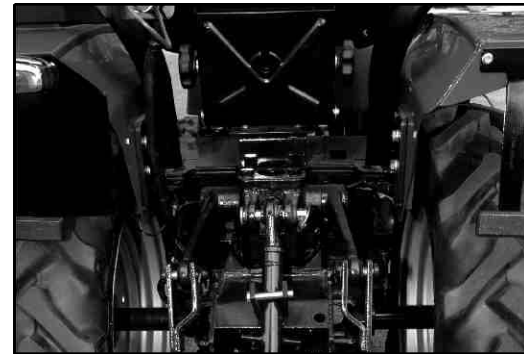

2. Apply a small quantity of oil to the depth control handle and mount it to the support. Fit a washer on the handle, mount it to the frame, fit another washer from the lower side, fasten with a castle nut so that the handle turns lightly and lock with a cotter pin. (Fig. 2)

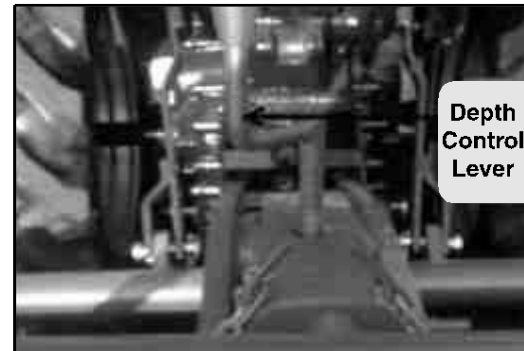

3. Fit a pin from the back side of the depth gauge wheel, mount it to the support and fix it with a snap pin.



### 11.3.3 MOUNTING

1. Level the rotary tiller horizontal and move the tractor back slowly. Insert the rotary tiller frame fitting position into the U-shaped position of the Bracket, fit the sleeve and fix with clevis pin and snap pin.



2. Set the control lever to the lowering position, lower the hydraulic lift arm down to the lowest position, mount the lift rod to the lift arm and fix it with clevis pin and snap pin.



3. Fitting the universal joint to the PTO shaft, fit clevis pin and fix with a snap pin.

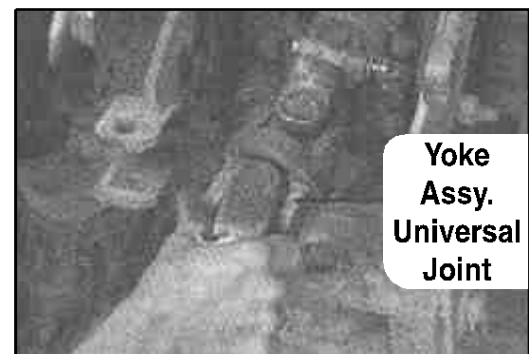

### 11.3.4 INSTALLING THE TILLING BLADE

#### CAUTION

Be sure to lock the tiller when installing or retightening the blade.

Start the engine, lift the rotary tiller, lock it by flow control valve on the tractor so that the rotary tiller may be prevented from lowering even if the hydraulic control lever is set to the lowering position. In the case of rotary tiller hang the chain to chain bracket to lock the tiller after the above procedure.

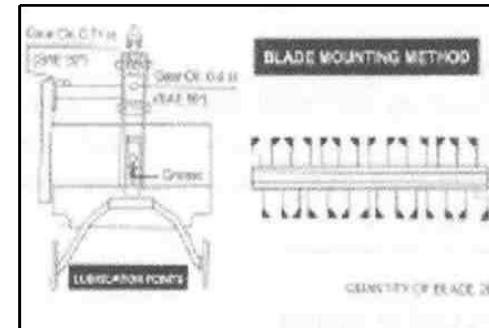

#### 1. IN THE CASE OF LEVELLING

To till the ground to be even, mount the tilling blades as shown.

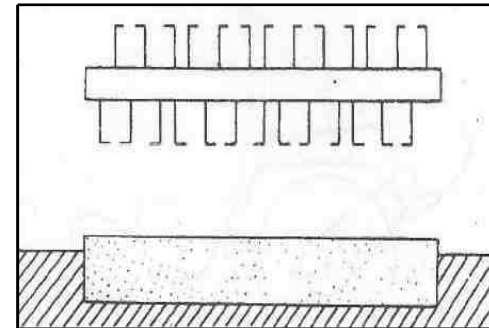

#### 2. IN THE CASE OF HILLING

In order to till the soil to be hilled like a ridge after tilling, set the tilling blades so that all the bends of the ends may be directed toward the center of the rotary shaft.

#### Note :

Tighten the tilling blades with torque 4 ~ 5 kg-m (29 ~ 36ft-lb) when mounting. Be sure to re-tighten them before operation as they are subjected to constant shock during the operation.

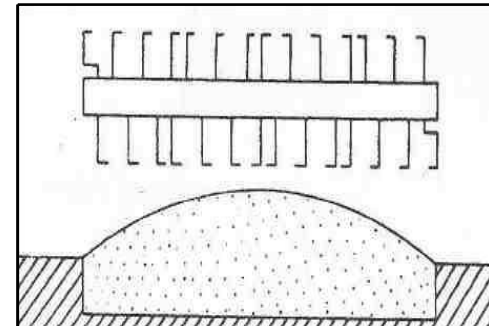

#### 3. IN THE CASE OF RIDGING

When mounting the ridger for ridging, arrange the blades so that the bends of the blades on the both sides may be toward the inward and the others all towards the outward of the rotary shaft. Be careful to avoid lapping of the central blades each other and leaving the soil untilled.

#### 11.3.5 MOUNTING THE RIDGER (OPTION)

Fit the ridger support to the end of the rotovator support insert the ridger and fix bolts. Adjust the height of the ridger according to the field conditions.

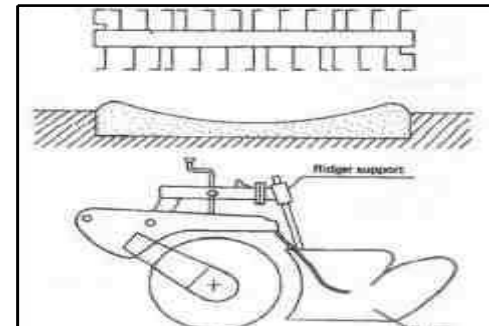

### 11.3.6 DEMOUNTING

1. Lower the rotary tiller slowly with the hydraulic control lever and remove the lift rod from the lift arm.

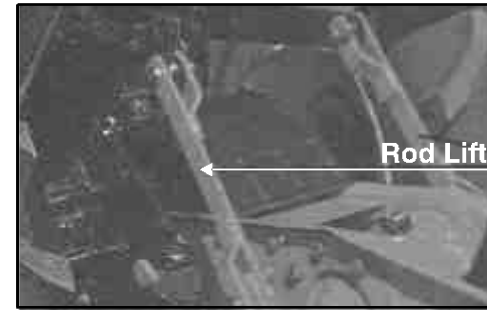

2. Draw out the bracket sleeve setting pin and remove the sleeve.
3. Pull out the rotary tiller backwards slowly holding the arm of the gauge wheel

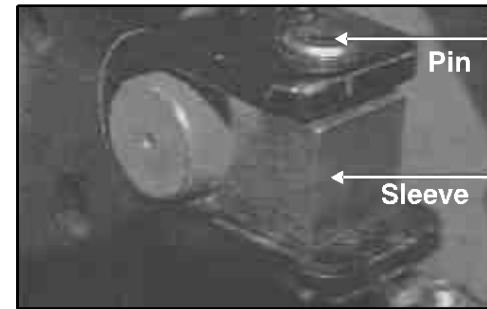

4. If required remove the snap pin of universal joint setting pin, draw out the pin and remove the universal joint from the PTO shaft. In the case of re-assemble push in the universal joint follow the above procedure in the reverse order.

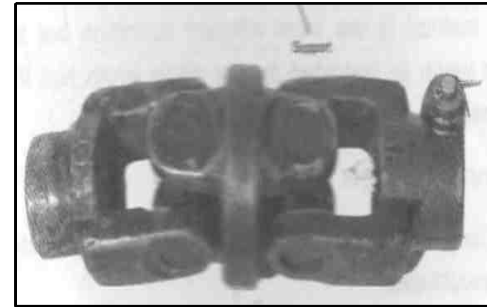

### 11.3.7 OPERATION

#### CAUTION

Observe the following precautions when operating the tractor with the tiller.

1. While tilling the soil with the rotary tiller, turning the tractor abruptly will cause the tilling blade to bend or damage gauge wheel arm or chain case. Be sure to lift the rotary tiller when turning the tractor.
2. Before replacing the tilling blade, or re-tightening the tilling blade set bolts, be sure to (1) stop the engine, (2) lock the hydraulic system by flow control valve, and (3) hang the rotary tiller lowering prevention chain to the chain bracket (S370/D) to ensure safety in operation.
3. When a person gets on the rotary tiller or any other things are placed thereon while the tractor is traveling on the road, the front becomes lighter, which could cause an accident.
4. When loading the tractor on a truck or the like for transportation, shift the gear to the reverse and drive the tractor backward at the lowest engine speed.
5. If the tractor front is floated on a truck or the like for transportation, shift the gear to the reverse and drive the tractor backward at the lowest engine speed.
6. If the tractor front is floated when crossing over a ridge or any other obstacles, shift the hydraulic control lever to lowering position quickly and lower the rotary tiller.
7. Be careful especially when operating on a steep slope.
8. Clean the tiller all the time after the operation and apply oil to working parts for rust-proofing.

## LOWERING SPEED CONTROL OF THE ROTARY TILLER

A flow control lever is provided on the tractor to control the lowering speed of the rotary tiller. Select the lowering speed according to the tractor speed and the field conditions.

### 11.3.8 TILLING METHOD

Two tilling methods are usable with the rotary tiller, successive tilling and alternate tilling

#### 1. SUCCESSIVE TILLING

Start to cultivate the soil straight from the corner of the plot leaving the headland, lift the tiller at the headland and turn the tractor to either side to continue the straight cultivation. This is the most efficient operation.

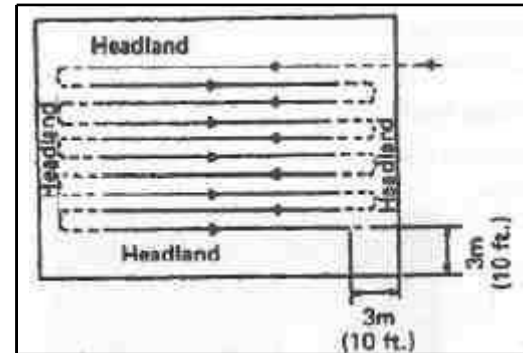

#### 2. ALTERNATE TILLING

Start the straight cultivation from the corner of the plot leaving the headland, lift this tiller at the headland and turn the tractor to either side.

Carry out the cultivation skipping a ridge alternately up to the corner, then return for cultivating the skipped ridges in the same way.

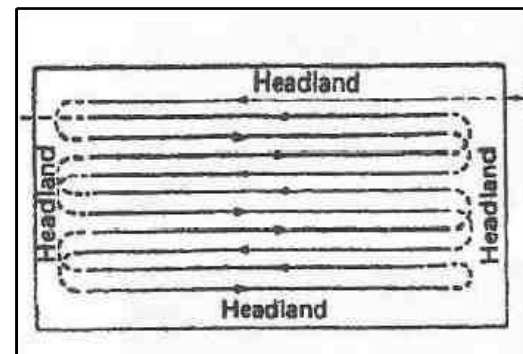

#### 3. TILLING THE HEADLAND

Cultivate the headland turning around 3 or 4 times from outside to inside in the order of (1), (2) and (3) as shown in the figure below.

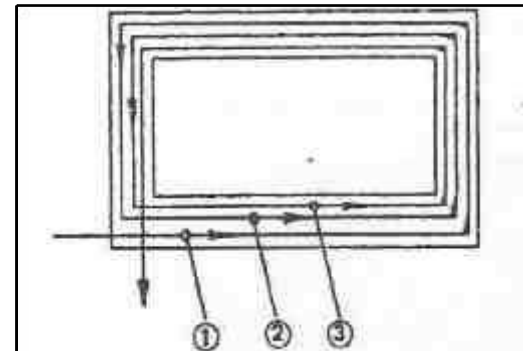

### RIDGING

#### CONSTANT RIDGING

This method is the most efficient operation but the ridge width is restricted by the tilling width just like the case of the alternate ridging.

1. Install the ridger.
2. Carry out the cultivation with each alternate ridge uncultivated.



### 13. SERVICE RECORD

**CH.NO.** \_\_\_\_\_ **ENGINE NO.** \_\_\_\_\_ **MODEL:** \_\_\_\_\_

S. NO	DATE/ HMR	DEALER CODE	BRIEF JOB DESCRIPTION	ACTION TAKEN	DEALER SIGN



## **International Tractors Limited**

**H.O.:** Pankaj Plaza-1, Plot No.2, Karkardooma,  
Commercial Complex, Delhi -110 092, INDIA

**Ph.:** +91-11-45192200, 22373785

**Works :** Jalandhar Road, Hoshiarpur-146 022 (Pb.) India

**Phone :** +91-1882-302-525/526

**web.:** [www.sonalika.com](http://www.sonalika.com), E-mail : [exports@sonalika.com](mailto:exports@sonalika.com)